

## Features

- 400W peak pulse power (8/20 $\mu$ s)
- Ultra low leakage: nA level
- Operating voltage: 7V or 12V
- Low clamping voltage
- Complies with following standards:
  - IEC 61000-4-2 (ESD) immunity test
    - Air discharge:  $\pm 30$ kV
    - Contact discharge:  $\pm 30$ kV
  - IEC61000-4-4 (EFT) 40A (5/50ns)
  - IEC61000-4-5 (Lightning) 17A (8/20 $\mu$ s)
- RoHS Compliant

## Applications

- Wireless System
- Networks
- Portable Instrumentation
- RS485 Ports

## Mechanical Characteristics

- Package: SOT-23
- Lead Finish: Matte Tin
- Case Material: “Green” Molding Compound.
- UL Flammability Classification Rating 94V-0
- Moisture Sensitivity: Level 3 per J-STD-020
- Terminal Connections: See Diagram Below

### Circuit Diagram

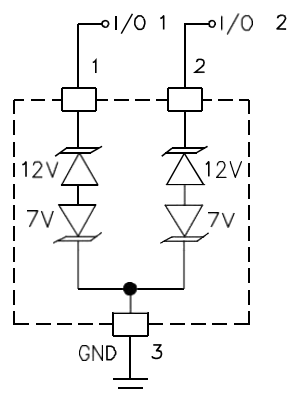

### Pin Configuration

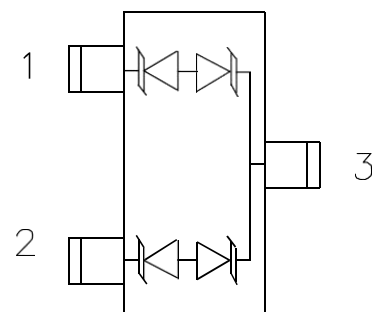

**Absolute Maximum Ratings** (Tamb=25°C unless otherwise specified)

Parameter	Symbol	Value	Unit
Peak Pulse Power (8/20μs)	Ppk	400	W
Peak Pulse Current (8/20μs)	Ipp	12	A
ESD per IEC 61000-4-2 (Air)	VESD	±30	kV
ESD per IEC 61000-4-2 (Contact)		±30	
Operating Temperature Range	TJ	-55 to +125	°C
Storage Temperature Range	Tstg	-55 to +150	°C

**Electrical Characteristics** (TA=25°C unless otherwise specified)

Parameter	Symbol	Pin 1 to 3 and 2 to 3 (12V TVS)			Pin 3 to 1 and 3 to 2 (7V TVS)			Unit	Test Condition
		Min	Typ	Max	Min	Typ	Max		
Reverse Working Voltage	VRWM			12			7	V	
Breakdown Voltage	VBR	13.3			7.5			V	IT = 1mA
Reverse Leakage Current	IR			0.05			2.0	uA	VR = VRWM
Clamping Voltage	VC			20			10	V	I <sub>PP</sub> = 5A (8 x 20μs pulse)
Clamping Voltage	VC			26			12	V	I <sub>PP</sub> = 12A (8 x 20μs pulse)
Junction Capacitance	CJ			75			75	pF	VR = 0V, f = 1MHz
Junction Capacitance	CJ		45			45		pF	VR = VRWM, f = 1MHz

**Electrical Parameter**

Symbol	Parameter
$I_{PP}$	Maximum Reverse Peak Pulse Current
$V_C$	Clamping Voltage @ $I_{PP}$
$V_{RWM}$	Working Peak Reverse Voltage
$I_R$	Maximum Reverse Leakage Current @ $V_{RWM}$
$I_T$	Test Current
$V_{BR}$	Breakdown Voltage @ $I_T$

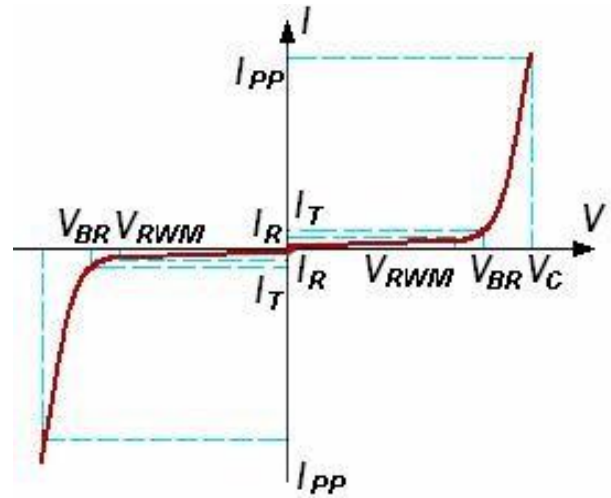

**FIG1: Pulse Waveform**

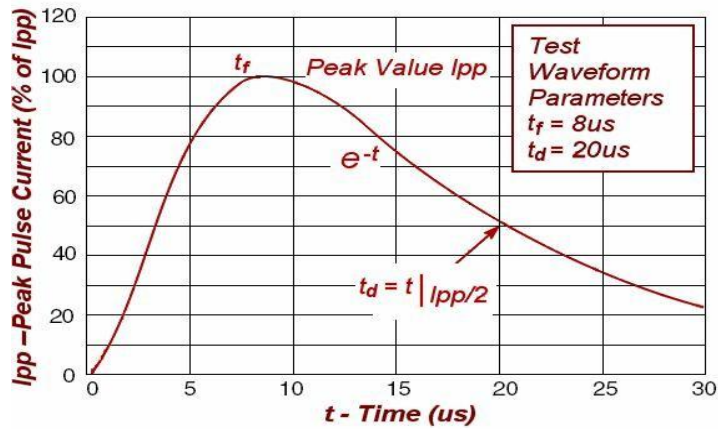

**FIG2: Power Derating**

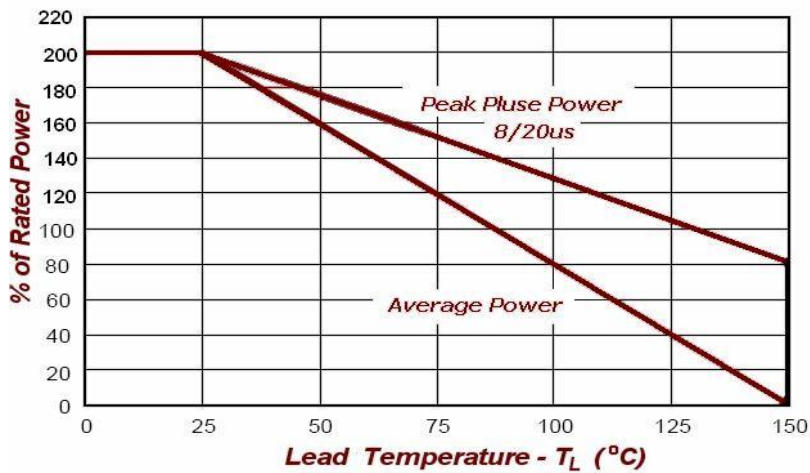

PACKAGE MECHANICAL DATA

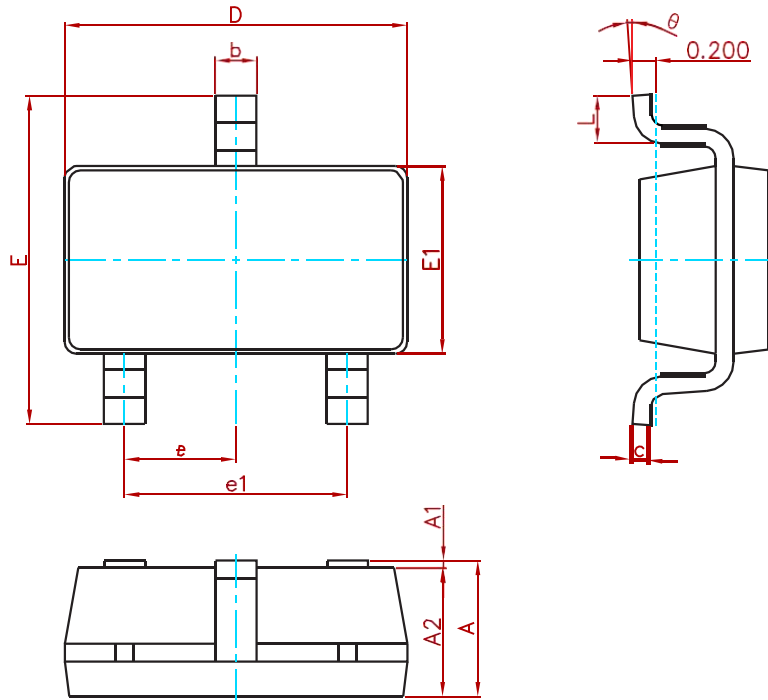

Symbol	Dimensions In Millimeters		Dimensions In Inches	
	Min.	Max.	Min.	Max.
A	1.050	1.250	0.041	0.049
A1	0.000	0.100	0.000	0.004
A2	1.050	1.150	0.041	0.045
b	0.300	0.500	0.012	0.020
c	0.100	0.200	0.004	0.008
D	2.820	3.020	0.111	0.119
E1	1.500	1.700	0.059	0.067
E	2.650	2.950	0.104	0.116
e	0.950(BSC)		0.037(BSC)	
e1	1.800	2.000	0.071	0.079
L	0.300	0.600	0.012	0.024
θ	0°	8°	0°	8°

Suggested Pad Layout

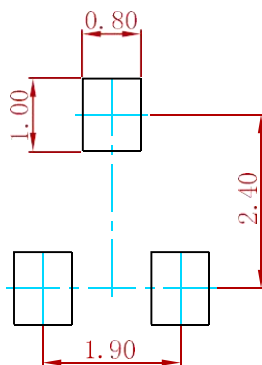

Note:  
 1. Controlling dimension: in millimeters.  
 2. General tolerance: ± 0.05mm.  
 3. The pad layout is for reference purposes only.

REEL SPECIFICATION

P/N	PKG	QTY
KRNP712	SOT-23	3000