

S9015 TRANSISTOR(PNP)

FEATURES

Complementary to S9014

MARKING: M6

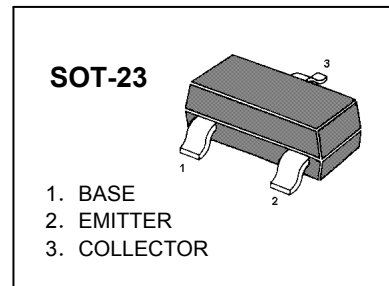

MAXIMUM RATINGS (T_A=25°C unless otherwise noted)

Symbol	Parameter	Value	Units
V _{CBO}	Collector-Base Voltage	-50	V
V _{CEO}	Collector-Emitter Voltage	-45	V
V _{EBO}	Emitter-Base Voltage	-5	V
I _C	Collector Current -Continuous	-0.1	A
P _C	Collector Power Dissipation	0.2	W
T _j	Junction Temperature	150	°C
T _{stg}	Storage Temperature	-55-150	°C

ELECTRICAL CHARACTERISTICS (T_{amb}=25°C unless otherwise specified)

Parameter	Symbol	Test conditions	MIN	TYP	MAX	UNIT
Collector-base breakdown voltage	V _{(BR)CBO}	I _C = -100µA, I _E = 0	-50			V
Collector-emitter breakdown voltage	V _{(BR)CEO}	I _C = -0.1mA, I _B = 0	-45			V
Emitter-base breakdown voltage	V _{(BR)EBO}	I _E = -100µA, I _C = 0	-5			V
Collector cut-off current	I _{CBO}	V _{CB} = -50V, I _E = 0			-0.1	µA
Emitter cut-off current	I _{EBO}	V _{EB} = -5V, I _C = 0			-0.1	µA
DC current gain	h _{FE}	V _{CE} = -5V, I _C = -1mA	200		450	
Collector-emitter saturation voltage	V _{CE(sat)}	I _C = -100mA, I _B = -10mA			-0.3	V
Base-emitter saturation voltage	V _{BE(sat)}	I _C = -100mA, I _B = -10mA			-1	V
Transition frequency	f _T	V _{CE} = -5V, I _C = -10mA f = 30MHz	150			MHz

Typical Characteristics

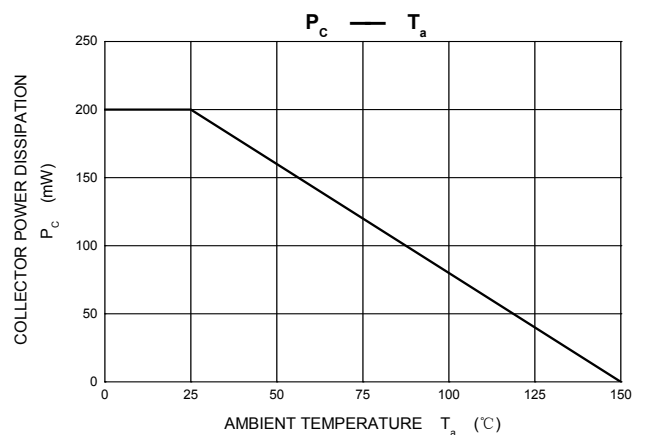
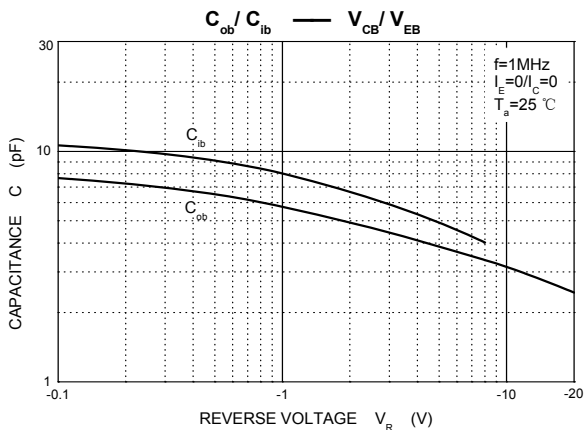
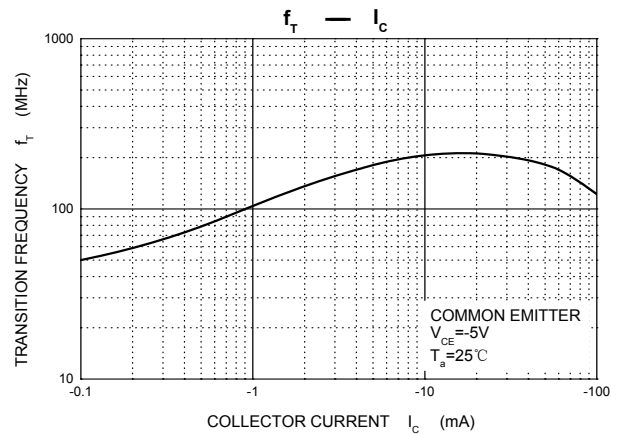
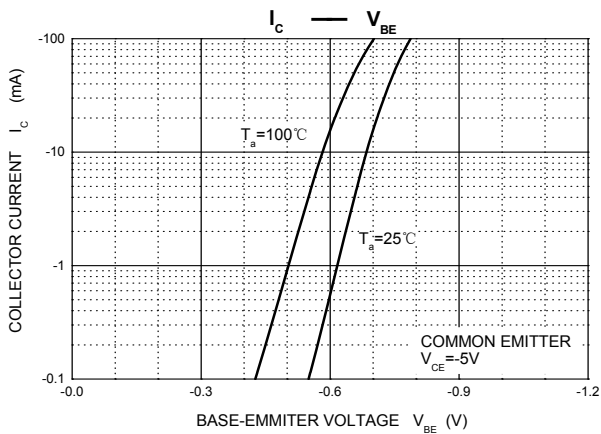
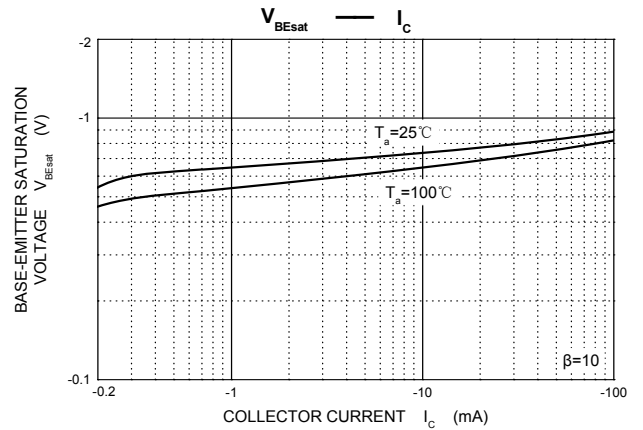
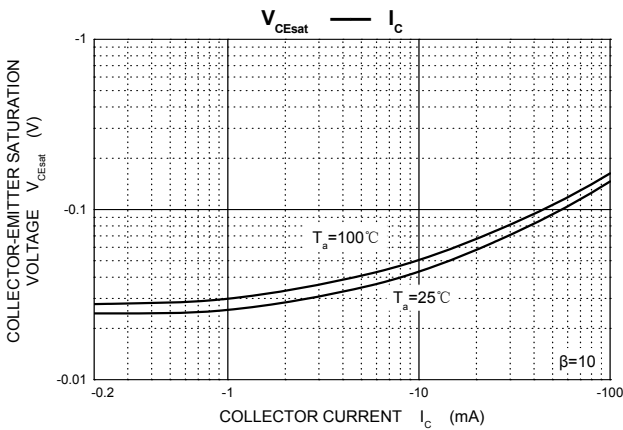
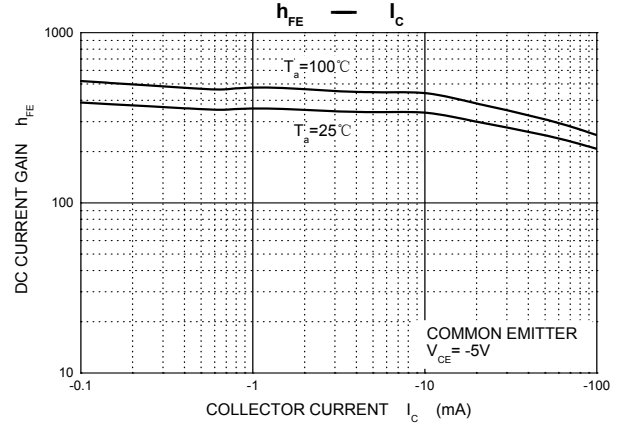
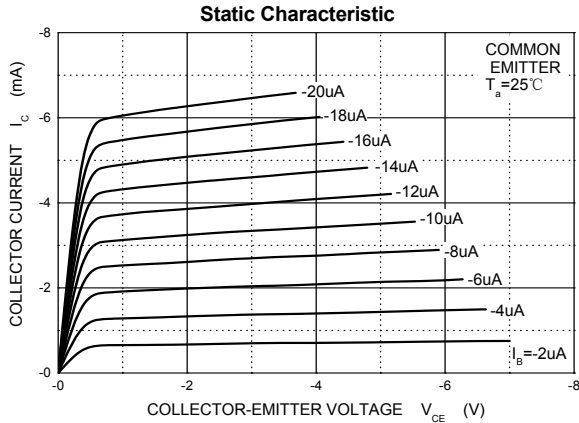

PACKAGE OUTLINE

Plastic surface mounted package; 3 leads

SOT-23

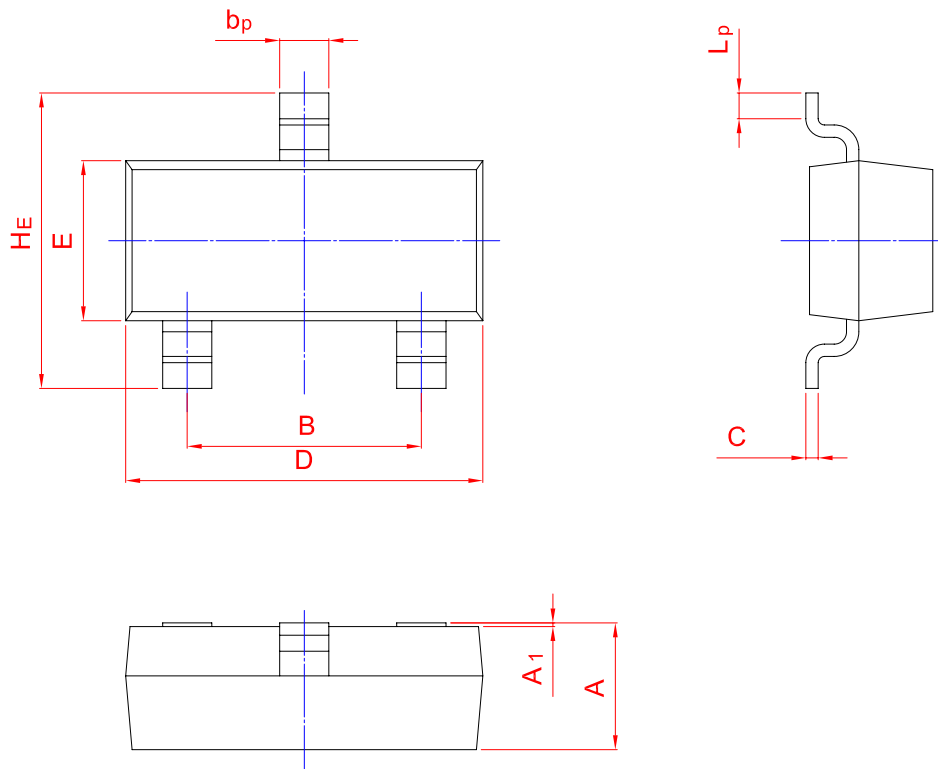
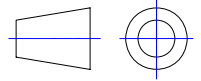

UNIT	A	B	bp	C	D	E	HE	A1	Lp
mm	1.40	2.04	0.50	0.19	3.10	1.65	3.00	0.100	0.50
	0.95	1.78	0.35	0.08	2.70	1.20	2.20	0.013	0.20