

N- and P- Channel 20 V (D-S) MOSFET

PRODUCT SUMMARY			
	V _{DS} (V)	R _{DS(on)} (Ω)	I _D (A)
N-Channel	20	0.090 at V _{GS} = 4.5 V	3.28
		0.110 at V _{GS} = 2.5 V	2.13
		0.130 at V _{GS} = 1.8 V	1.50
P-Channel	- 20	0.155 at V _{GS} = - 4.5 V	- 2.80
		0.190 at V _{GS} = - 2.5 V	- 1.81
		0.220 at V _{GS} = - 1.8 V	- 1.15

FEATURES

- Halogen-free According to IEC 61249-2-21 Definition
- TrenchFET® Power MOSFETs: 1.8 V Rated
- Thermally Enhanced SC-70 Package
- Fast Switching
- Compliant to RoHS Directive 2002/95/EC



RoHS
COMPLIANT
HALOGEN
FREE
Available

APPLICATIONS

- Load Switch for Portable Devices

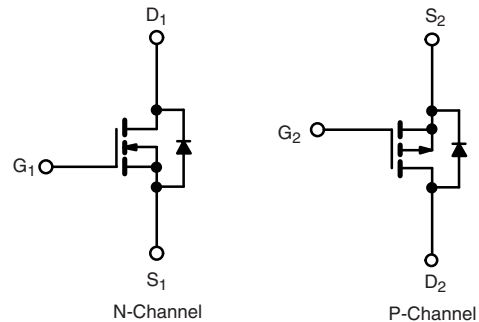
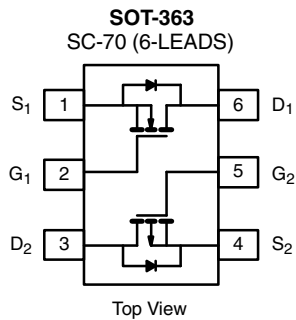

ABSOLUTE MAXIMUM RATINGS T _A = 25 °C, unless otherwise noted							
Parameter	Symbol	N-Channel		P-Channel		Unit	
		5 s	Steady State	5 s	Steady State		
Drain-Source Voltage	V _{DS}	20		- 20		V	
Gate-Source Voltage	V _{GS}	± 20		± 20		V	
Continuous Drain Current (T _J = 150 °C) ^a	I _D	T _A = 25 °C	3.28	3.03	- 2.80	- 2.58	A
		T _A = 85 °C	2.12	1.81	- 1.72	- 1.53	
Pulsed Drain Current	I _{DM}	9.5		- 8.5			
Continuous Source Current (Diode Conduction) ^a	I _S	2.61	2.48	- 1.61	-1.48		
Maximum Power Dissipation ^a	P _D	T _A = 25 °C	1.24	1.17	1.10	0.97	W
		T _A = 85 °C	0.88	0.75	0.66	0.5	
Operating Junction and Storage Temperature Range	T _J , T _{stg}	- 55 to 150				°C	

THERMAL RESISTANCE RATINGS					
Parameter		Symbol	Typical	Maximum	Unit
Maximum Junction-to-Ambient ^a	t ≤ 5 s	R _{thJA}	130	170	°C/W
	Steady State		170	220	
Maximum Junction-to-Foot (Drain)	Steady State	R _{thJF}	80	100	

Notes:

a. Surface mounted on 1" x 1" FR4 board.

SPECIFICATIONS $T_J = 25\text{ }^\circ\text{C}$, unless otherwise noted								
Parameter	Symbol	Test Conditions		Min.	Typ.	Max.	Unit	
Static								
Gate Threshold Voltage	$V_{GS(th)}$	$V_{DS} = V_{GS}, I_D = 100\ \mu\text{A}$	N-Ch	0.45		1	V	
		$V_{DS} = V_{GS}, I_D = -100\ \mu\text{A}$	P-Ch	-0.45		1		
Gate-Body Leakage	I_{GSS}	$V_{DS} = 0\ \text{V}, V_{GS} = \pm 8\ \text{V}$	N-Ch P-Ch			± 100 ± 100	nA	
Zero Gate Voltage Drain Current	I_{DSS}	$V_{DS} = 16\ \text{V}, V_{GS} = 0\ \text{V}$	N-Ch			1	μA	
		$V_{DS} = -16\ \text{V}, V_{GS} = 0\ \text{V}$	P-Ch			-1		
		$V_{DS} = 16\ \text{V}, V_{GS} = 0\ \text{V}, T_J = 85\text{ }^\circ\text{C}$	N-Ch			5		
		$V_{DS} = -16\ \text{V}, V_{GS} = 0\ \text{V}, T_J = 85\text{ }^\circ\text{C}$	P-Ch			-5		
On-State Drain Current ^a	$I_{D(on)}$	$V_{DS} \geq 5\ \text{V}, V_{GS} = 4.5\ \text{V}$	N-Ch	2			A	
		$V_{DS} \leq -5\ \text{V}, V_{GS} = -4.5\ \text{V}$	P-Ch	-2				
Drain-Source On-State Resistance ^a	$R_{DS(on)}$	$V_{GS} = 4.5\ \text{V}, I_D = 2.55\ \text{A}$	N-Ch		0.090		Ω	
		$V_{GS} = -4.5\ \text{V}, I_D = -1.85\ \text{A}$	P-Ch		0.155			
		$V_{GS} = 2.5\ \text{V}, I_D = 1.55\ \text{A}$	N-Ch		0.110			
		$V_{GS} = -2.5\ \text{V}, I_D = -1.35\ \text{A}$	P-Ch		0.190			
		$V_{GS} = 1.8\ \text{V}, I_D = 0.50\ \text{A}$	N-Ch		0.130			
		$V_{GS} = -1.8\ \text{V}, I_D = -0.50\ \text{A}$	P-Ch		0.220			
Forward Transconductance ^a	g_{fs}	$V_{DS} = 10\ \text{V}, I_D = 1.13\ \text{A}$	N-Ch		2.6		S	
		$V_{DS} = -10\ \text{V}, I_D = -0.88\ \text{A}$	P-Ch		1.5			
Diode Forward Voltage ^a	V_{SD}	$I_S = 0.48\ \text{A}, V_{GS} = 0\ \text{V}$	N-Ch		0.8	1.2	V	
		$I_S = -0.48\ \text{A}, V_{GS} = 0\ \text{V}$	P-Ch		-0.8	-1.2		
Dynamic^b								
Total Gate Charge	Q_g	N-Channel $V_{DS} = 10\ \text{V}, V_{GS} = 4.5\ \text{V}, I_D = 2.55\ \text{A}$ P-Channel $V_{DS} = -10\ \text{V}, V_{GS} = -4.5\ \text{V}, I_D = -0.88\ \text{A}$	N-Ch		1.25	2	nC	
			P-Ch		1.2	1.8		
Gate-Source Charge	Q_{gs}		N-Ch		0.21			
			P-Ch		0.3			
Gate-Drain Charge	Q_{gd}		N-Ch		0.3			
			P-Ch		0.21			
Turn-On Delay Time	$t_{d(on)}$	N-Channel $V_{DD} = 10\ \text{V}, R_L = 20\ \Omega$ $I_D \cong 0.5\ \text{A}, V_{GEN} = 4.5\ \text{V}, R_g = 6\ \Omega$ P-Channel $V_{DD} = -10\ \text{V}, R_L = 20\ \Omega$ $I_D \cong -0.5\ \text{A}, V_{GEN} = -4.5\ \text{V}, R_g = 6\ \Omega$	N-Ch		15	25	ns	
			P-Ch		18	30		
Rise Time	t_r		N-Ch		22	35		
			P-Ch		25	40		
Turn-Off Delay Time	$t_{d(off)}$		N-Ch		25	40		
			P-Ch		15	25		
Fall Time	t_f		N-Ch		12	20		
			P-Ch		12	20		
Reverse Recovery Time	t_{rr}		$I_F = 0.48\ \text{A}, di/dt = 100\ \text{A}/\mu\text{s}$	N-Ch		30		60
				P-Ch		30		60

Notes:

- a. Pulse test; pulse width $\leq 300\ \mu\text{s}$, duty cycle $\leq 2\%$.
b. Guaranteed by design, not subject to production testing.

Stresses beyond those listed under "Absolute Maximum Ratings" may cause permanent damage to the device. These are stress ratings only, and functional operation of the device at these or any other conditions beyond those indicated in the operational sections of the specifications is not implied. Exposure to absolute maximum rating conditions for extended periods may affect device reliability.

N-CHANNEL TYPICAL CHARACTERISTICS 25 °C, unless otherwise noted

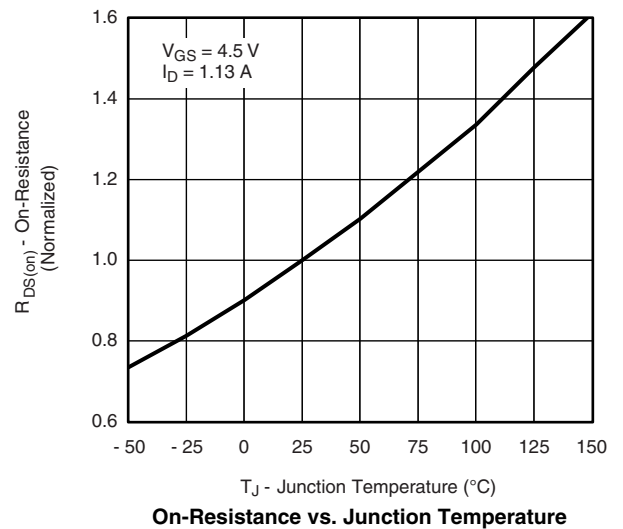
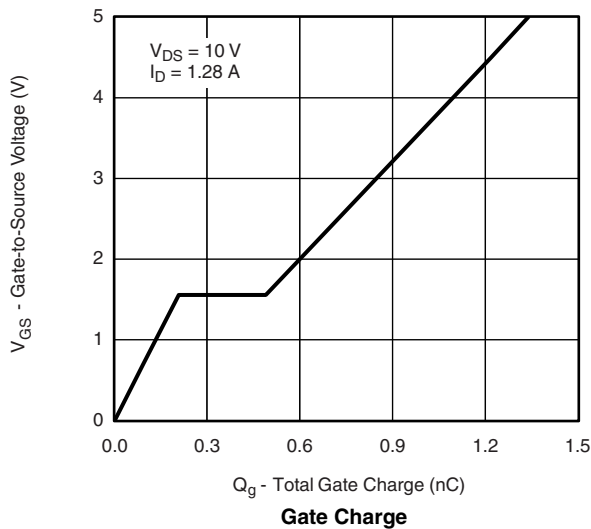
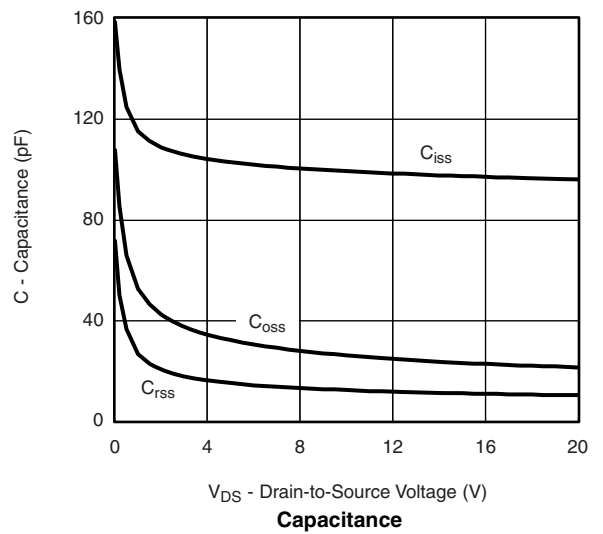
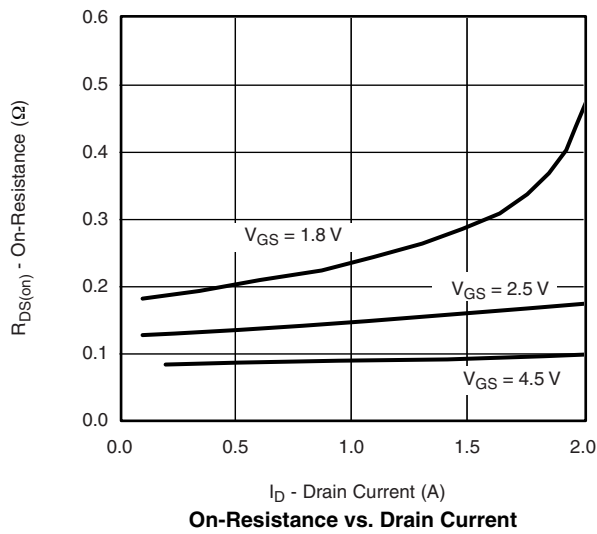
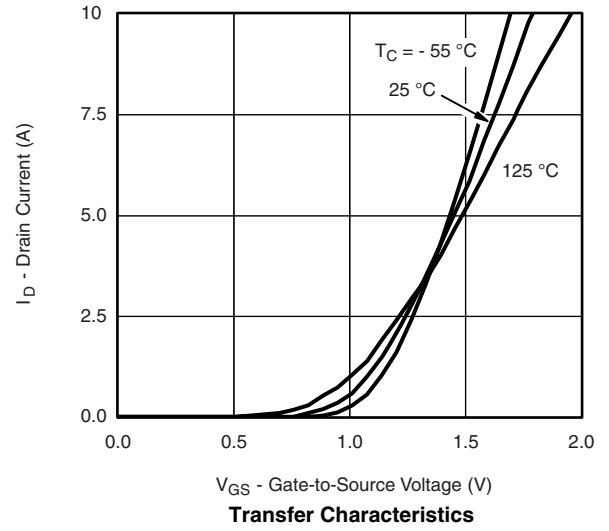
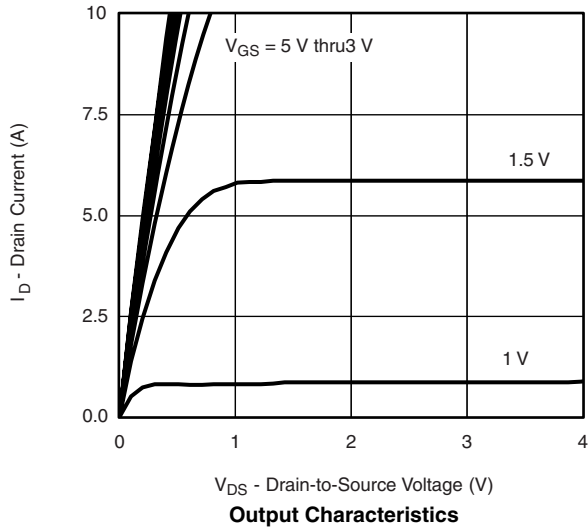

N-CHANNEL TYPICAL CHARACTERISTICS 25 °C, unless otherwise noted

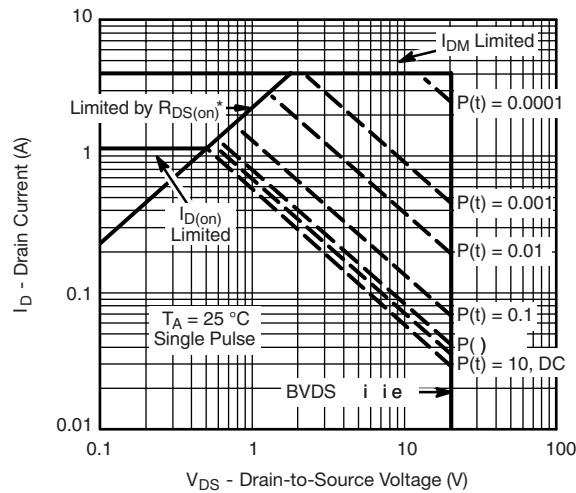
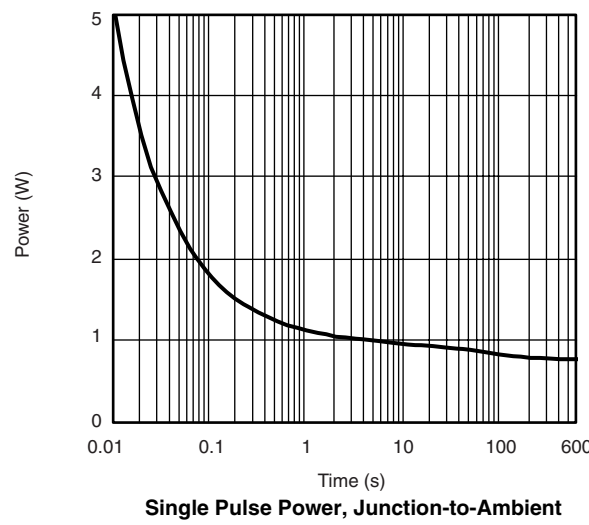
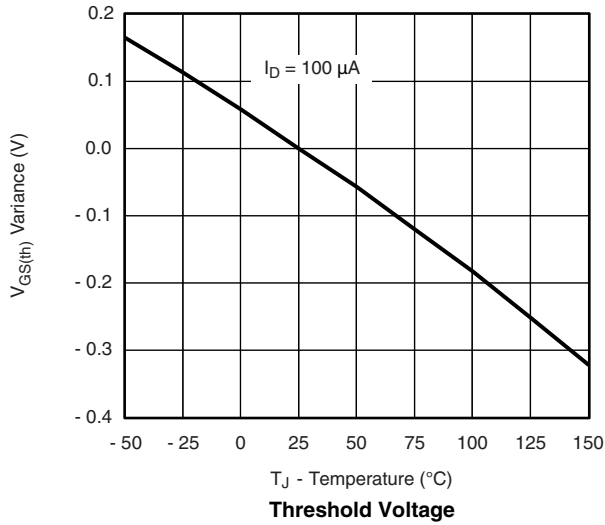
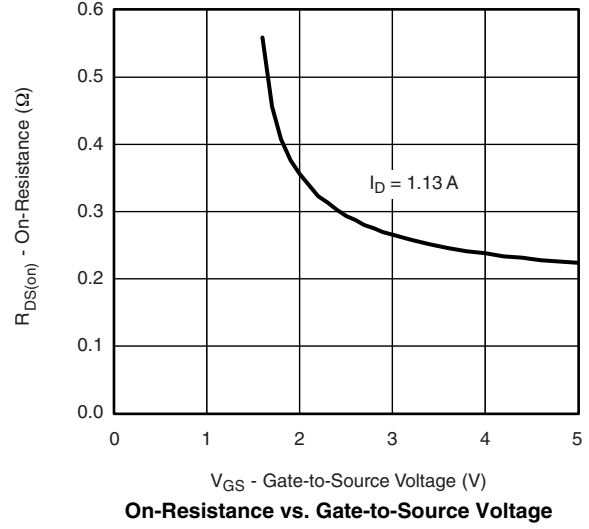
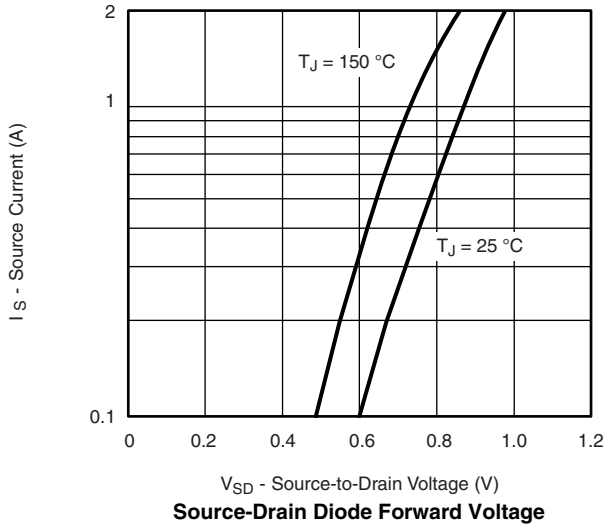

* $V_{GS} >$ minimum V_{GS} at which $R_{DS(on)}$ is specified
Safe Operating Area, Junction-to-Ambient

N-CHANNEL TYPICAL CHARACTERISTICS 25 °C, unless otherwise noted

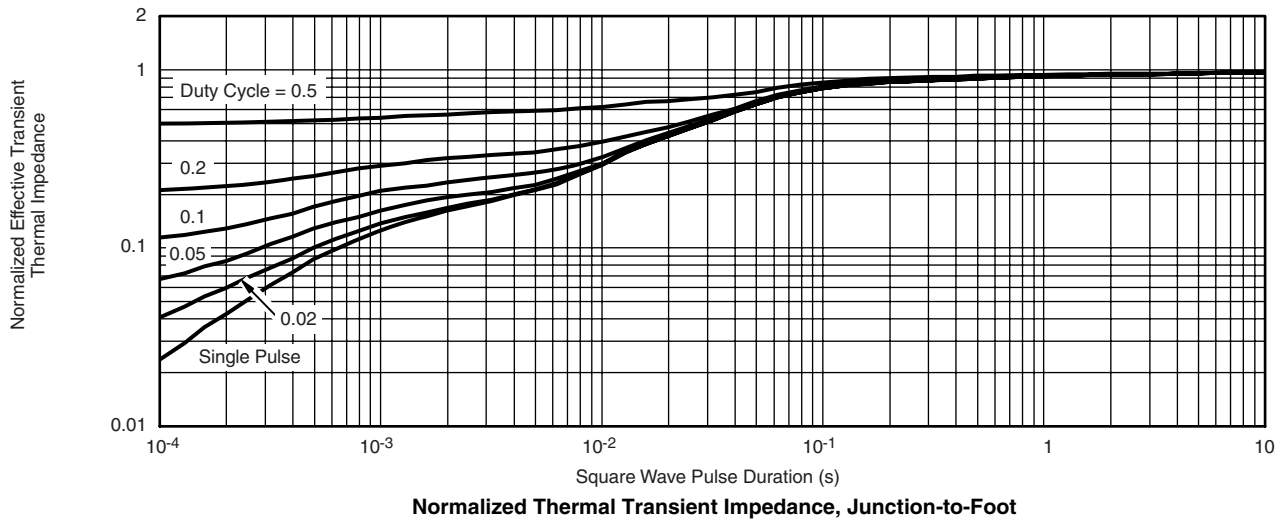
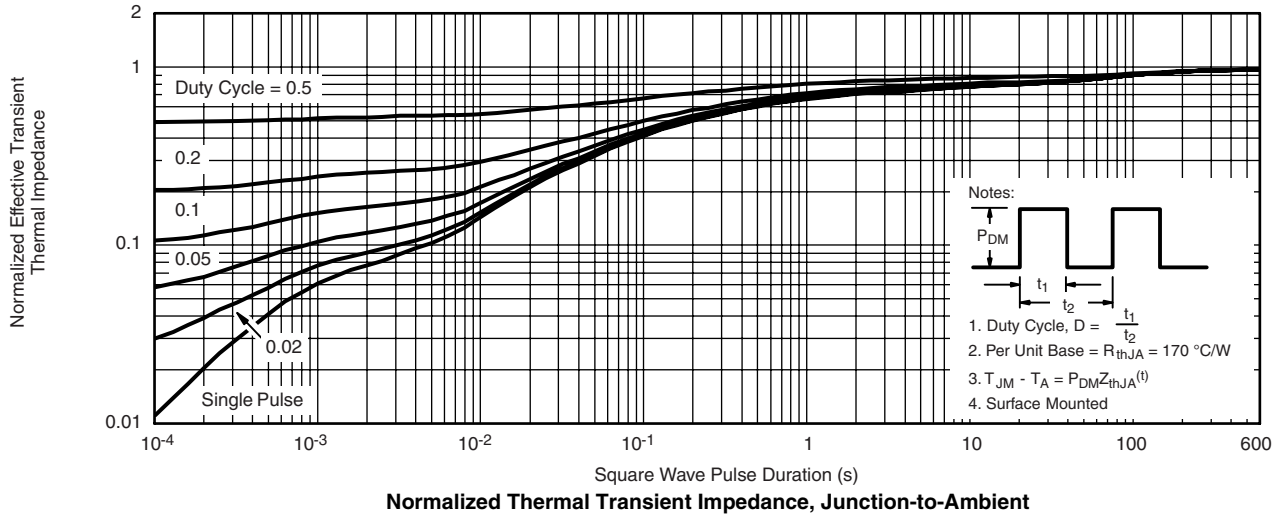

P-CHANNEL TYPICAL CHARACTERISTICS 25 °C, unless otherwise noted

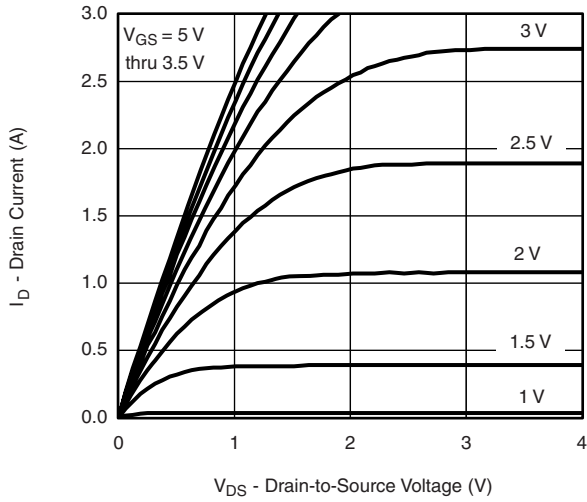

Output Characteristics

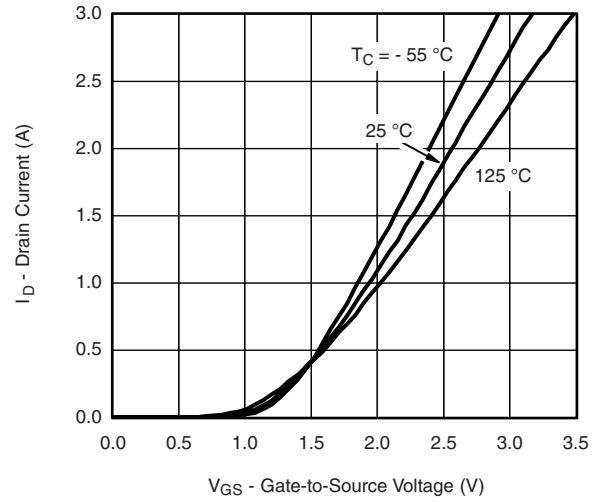

Transfer Characteristics

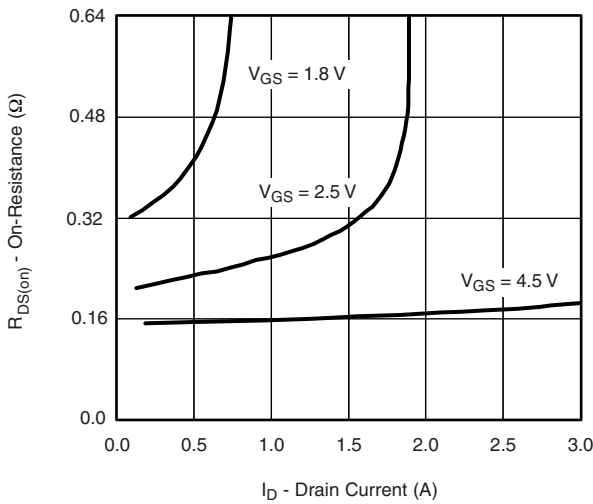

On-Resistance vs. Drain Current

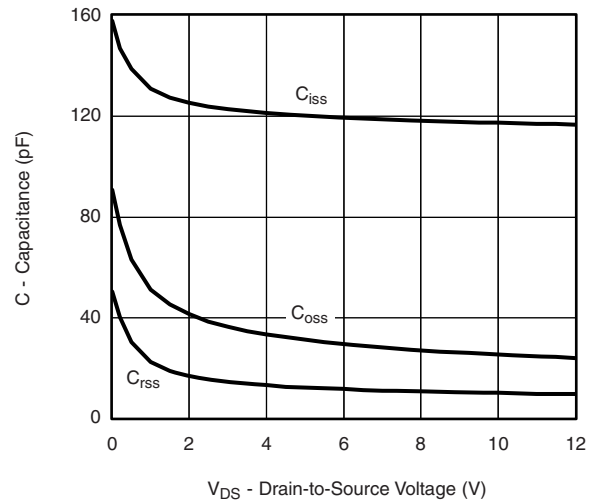

Capacitance

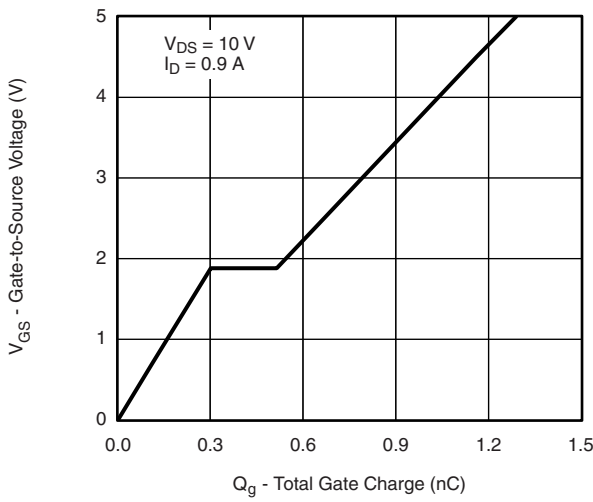

Gate Charge

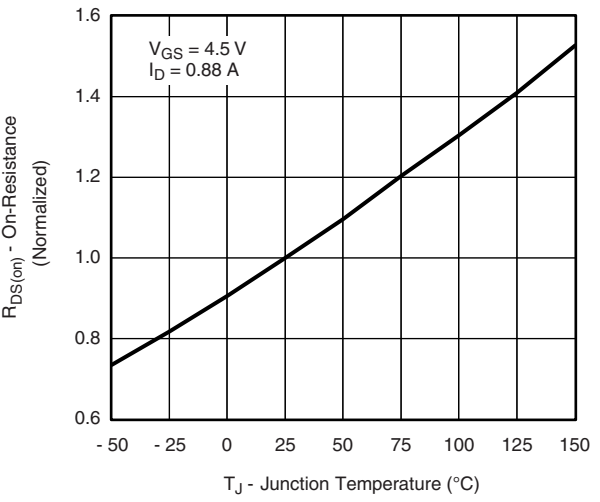

On-Resistance vs. Junction Temperature

P-CHANNEL TYPICAL CHARACTERISTICS 25 °C, unless otherwise noted

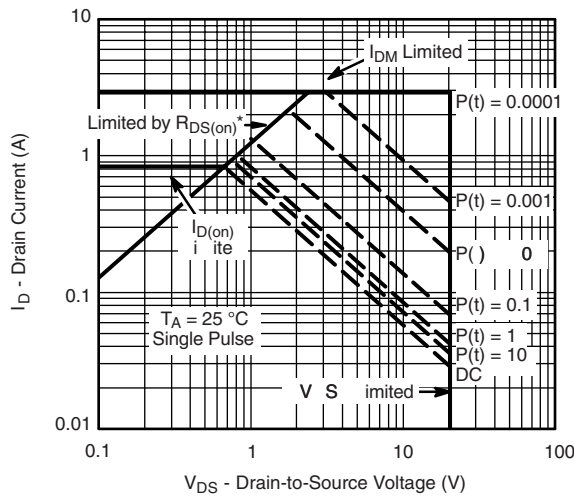
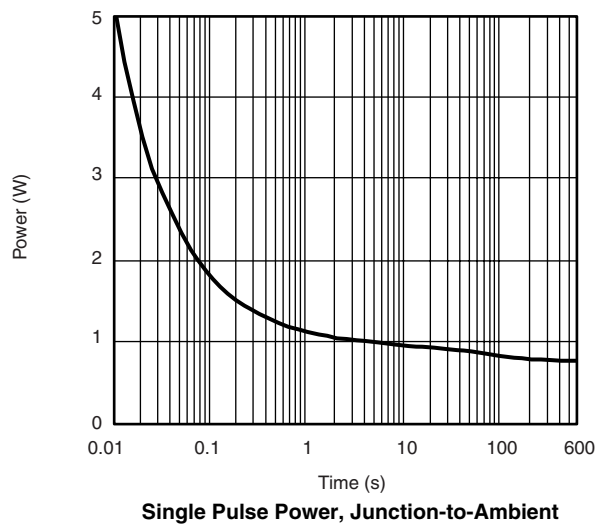
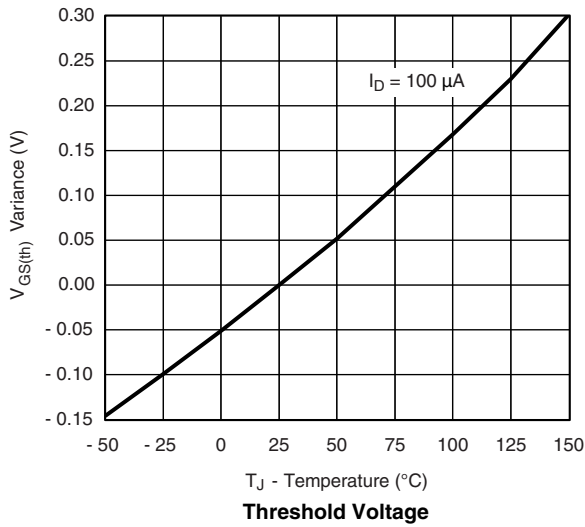
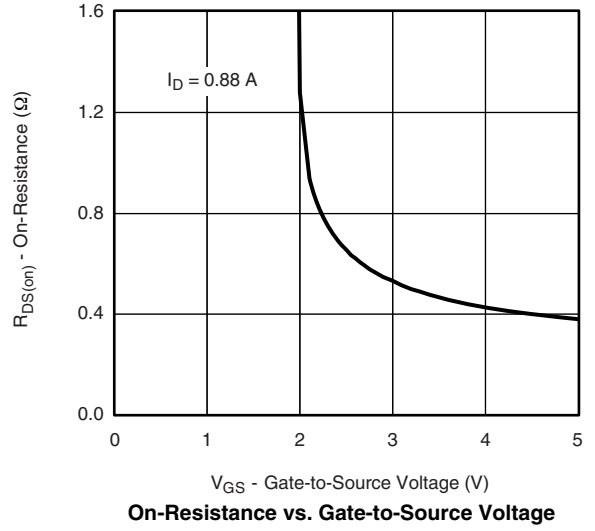
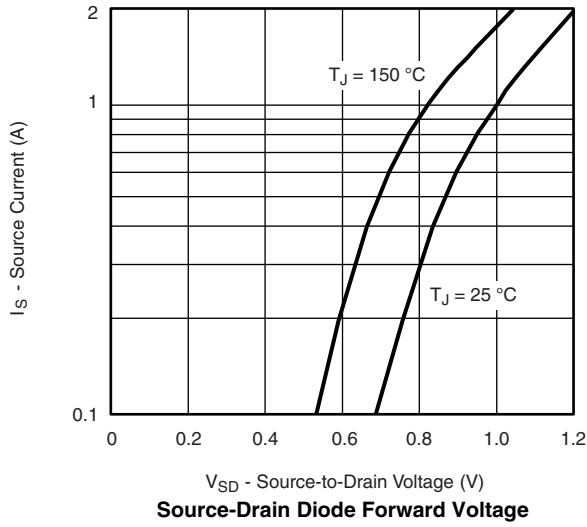

* $V_{GS} >$ minimum V_{GS} at which $R_{DS(on)}$ is specified

Safe Operating Area, Junction-to-Ambient

P-CHANNEL TYPICAL CHARACTERISTICS 25 °C, unless otherwise noted

