



## Insertion magnetic inductive flowmeter

- Sensor without moving parts
- Flowmeter with On/Off control
- Application related calibration by Teach-In function
- Clean in place (CIP)
- FDA-compliant materials

Product variants described in the data sheet may differ from the product presentation and description.

### Can be combined with

- |  |   |
|--|---|
|  | <p><b>Type 8025</b> ▶<br/>Insertion flowmeter or batch controller with paddle wheel and flow transmitter or remote batch controller</p> |
|  | <p><b>Type 8802</b> ▶<br/>ELEMENT continuous control valve systems - overview</p>   |
|  | <p><b>Type 8619</b> ▶<br/>multiCELL - Multi-channel and multi-function transmitter/controller</p>                                       |
|  | <p><b>Type 8644</b> ▶<br/>Remote Process Actuation Control System AirLINE</p>   |

### Type description

The electromagnetic flowmeter 8041 is made up of an electronic module and a sensor consisting of PVDF or stainless steel material. It has been designed to measure a flow rate of neutral and slightly aggressive fluids with a conductivity of more than 20 µS/cm in DN 06...DN 400 pipes.

It is fitted with a 4...20 mA output, a pulse output and a relay output. The different parameters can be set by means of 5 DIP switches, a push-button and a 10-field LED bar graph.

This flowmeter is available either with a G 2" connection with a PVDF sensor or, a G 2" or clamp connection with a stainless steel sensor which are designed for use with Type S020 Insertion fitting.

The variant with a stainless steel sensor can be used in applications with higher pressures (PN 16) and higher temperatures (150 °C).

## Table of contents

<b>1. General technical data</b>	<b>4</b>
<hr/>	
<b>2. Approvals</b>	<b>6</b>
2.1. Certifications .....	6
2.2. Pressure equipment directive .....	6
Device used on a pipe .....	6
<hr/>	
<b>3. Materials</b>	<b>7</b>
3.1. Chemical Resistance Chart – Bürkert resistApp.....	7
3.2. Material specifications .....	7
<hr/>	
<b>4. Dimensions</b>	<b>8</b>
4.1. Flowmeter .....	8
With G 2" process connection .....	8
With clamp process connection .....	8
4.2. Flowmeter installed in a fitting Type S020 .....	9
With G 2" process connection .....	9
With clamp process connection .....	9
<hr/>	
<b>5. Performance specifications</b>	<b>10</b>
5.1. Pressure temperature diagram.....	10
Flowmeter with a PVDF sensor.....	10
Flowmeter with a stainless steel sensor .....	10
<hr/>	
<b>6. Product installation</b>	<b>11</b>
6.1. Installation notes.....	11
6.2. Mounting options.....	11
<hr/>	
<b>7. Product operation</b>	<b>12</b>
7.1. Measuring principle .....	12
7.2. Functional overview .....	12
Display on the electronic board (PCB).....	12
Operating levels .....	13
<hr/>	
<b>8. Product design and assembly</b>	<b>14</b>
8.1. Product assembly .....	14
<hr/>	
<b>9. Networking and combination with other Bürkert products</b>	<b>15</b>
9.1. Networking and combination of the device.....	15
9.2. Combination of the device with available Type S020 Insertion fittings DN .....	15
9.3. Remote transmitters Type 8025 which can be connected to the Type 8041 flowmeter.....	15
<hr/>	
<b>10. Ordering information</b>	<b>16</b>
10.1. Bürkert eShop – Easy ordering and quick delivery.....	16
10.2. Recommendation regarding product selection .....	16
Flowmeter with G 2" process connection.....	16
Flowmeter with clamp process connection .....	16
10.3. Bürkert product filter.....	16
10.4. Ordering chart.....	17
Flowmeter with G 2" process connection.....	17

Flowmeter with clamp process connection .....	17
Remote transmitters Type 8025 which can be connected to the Type 8041 flowmeter.....	18
10.5. Ordering chart accessories.....	18

## 1. General technical data

### Note:

If the device is mounted in a humid environment or outside, then the maximum voltage allowed is **35 V DC** instead of 36 V DC.

### Product properties

#### Material

Please make sure the device materials are compatible with the fluid you are using.

Detailed information can be found in chapter [“3.1. Chemical Resistance Chart – Bürkert resistApp” on page 7.](#)

Detailed information on the materials can be found in chapter [“3.2. Material specifications” on page 7.](#)

#### Non wetted parts

Front panel film	Polyester
Cover	<ul style="list-style-type: none"> <li>• Variant with flow sensor in PVDF: PC</li> <li>• Variant with flow sensor in stainless steel: back PPA (glass fibre reinforced)</li> </ul>
Housing	<ul style="list-style-type: none"> <li>• Variant with flow sensor in PVDF: PC (glass fibre reinforced)</li> <li>• Variant with flow sensor in stainless steel: back PPA (glass fibre reinforced)</li> </ul>
Screw	Stainless steel
Union nut	<ul style="list-style-type: none"> <li>• Variant with flow sensor in PVDF: PC</li> <li>• Variant with flow sensor in stainless steel: back PPA (glass fibre reinforced)</li> </ul>
Mounting ring	Polysulphone, glass fibre reinforced
Seal	NBR
Armature	Stainless steel 1.4404/316L (for flowmeter with clamp process connection, over the clamp)
Cable gland	PA with neoprene seal

#### Wetted parts

Clamp	Stainless steel 1.4404/316L
Sensor armature	<ul style="list-style-type: none"> <li>• PVDF</li> <li>• Stainless steel 1.4404/316L</li> </ul>
Electrode holder	Only with variant with flow sensor in stainless steel: PEEK (conform to FDA)
Electrode	<ul style="list-style-type: none"> <li>• Stainless steel 1.4404/316L</li> <li>• Alloy C22</li> </ul>
Earth ring	Only with variant with flow sensor in PVDF: <ul style="list-style-type: none"> <li>• Stainless steel 1.4404/316L</li> <li>• Alloy C22</li> </ul>
Seal	<ul style="list-style-type: none"> <li>• For flowmeter with G 2" process connection: <ul style="list-style-type: none"> <li>– FKM (approved FDA)</li> <li>– EPDM (conform to FDA)</li> </ul> </li> <li>• For flowmeter with clamp process connection: (to be ordered separately, detailed information can be found in chapter <a href="#">“10.5. Ordering chart accessories” on page 18.</a>) <ul style="list-style-type: none"> <li>– EPDM</li> <li>– FEP</li> </ul> </li> </ul>
Surface quality	For clamp process connection: Ra <0.8 µm
Compatibility	<ul style="list-style-type: none"> <li>• For flowmeter with G 2" process connection: Any pipe from DN 06...DN 400 which is fitted with Bürkert S020 Insertion fitting with G 2" sensor connection.</li> <li>• For flowmeter with clamp process connection: Any pipe from DN 32...DN 100 which is fitted with Bürkert S020 Insertion fitting with clamp sensor connection.</li> </ul> <p>For the selection of the nominal diameter of the Insertion fittings, see <a href="#">data sheet Type S020 ▶</a>.</p>
Pipe diameter	<ul style="list-style-type: none"> <li>• For flowmeter with G 2" process connection: DN 06...DN 400</li> <li>• For flowmeter with clamp process connection: DN 32...DN 100</li> </ul>
Dimensions	Detailed information can be found in chapter <a href="#">“4. Dimensions” on page 8.</a>
Measuring element	Electrodes
Measuring principle	Electromagnetic
Measuring range	<ul style="list-style-type: none"> <li>• Flow rate: 0.4...75000 l/min</li> <li>• Flow velocity: 0.2...10 m/s</li> </ul>

Performance data	
Measurement deviation	<ul style="list-style-type: none"> <li>Teach-In: <math>\pm 0.5\%</math> of the measured value<sup>1)</sup> at Teach-In flow rate value</li> <li>Standard K-factor: <math>\pm 3.5\%</math> of the measured value<sup>1)</sup></li> </ul>
Linearity	$\pm 0.5\%$ of full scale <sup>1)</sup>
Repeatability	$\pm 0.25\%$ of the measured value <sup>1)</sup>
4...20 mA output uncertainty	$\pm 1\%$ of range
Electrical data	
Operating voltage	18...36 V DC $\pm 0.5\%$ , filtered and regulated (3 wires)
Power source (not supplied)	Limited power source according to UL/EN 60950-1 standards or limited energy circuit according to UL/EN 61010-1 §9.4
DC reverse polarity protection	Yes
Current consumption	$\leq 220$ mA (at 18 V DC)
Output	<ul style="list-style-type: none"> <li>Current: <ul style="list-style-type: none"> <li>4...20 mA</li> <li>Sink or source (by wiring)</li> <li>100 ms refresh time</li> <li>Max. loop impedance: 1100 <math>\Omega</math> at 36 V DC; 330 <math>\Omega</math> at 18 V DC</li> </ul> </li> <li>Frequency: <ul style="list-style-type: none"> <li>0...240 Hz</li> <li>Duty cycle (pulse duration/period) = 50 % <math>\pm 1\%</math></li> <li>100 mA max.</li> <li>Protected against short-circuits and polarity reversals</li> </ul> </li> <li>Relay: <ul style="list-style-type: none"> <li>Normally open or normally closed (depending on wiring)</li> <li>30 V AC/42 V<sub>peak</sub>/2 A or 60 V DC/1 A</li> </ul> </li> </ul>
Fault signal	<ul style="list-style-type: none"> <li>Full scale exceeding: 22 mA and 256 Hz</li> <li>Fault signalling: 22 mA and 0 Hz</li> </ul>
Voltage supply cable	<ul style="list-style-type: none"> <li>Shielded</li> <li>External diameter (cable): 6...12 mm (1 cable per cable gland) or 4...5 mm when using a multi-way seal (2 cables per cable gland)</li> <li>Cross section of wires: 0.5...1.5 mm<sup>2</sup></li> </ul>
Medium data	
Fluid temperature	<ul style="list-style-type: none"> <li>Variant with flow sensor in PVDF: 0...+80 °C (+32...+176 °F) (depends on fitting)</li> <li>Variant with flow sensor in stainless steel: -15...+150 °C (+5...+302 °F) (depends on fitting)</li> </ul> <p>Detailed information can be found in chapter <b>"5.1. Pressure temperature diagram"</b> on page <b>10</b> and in the data sheet of the fitting, see <b>data sheet Type S020</b> ►.</p>
Fluid pressure	<ul style="list-style-type: none"> <li>Variant with flow sensor in PVDF: max. PN 10 (145.1 PSI)</li> <li>Variant with flow sensor in stainless steel: <ul style="list-style-type: none"> <li>Max. PN 10 (145.1 PSI) (with plastic fitting)</li> <li>Max. PN 16 (232.16 PSI) (with metal fitting)</li> </ul> </li> </ul> <p>Detailed information can be found in chapter <b>"5.1. Pressure temperature diagram"</b> on page <b>10</b> and in the data sheet of the fitting, see <b>data sheet Type S020</b> ►.</p>
Viscosity	<1000 mPa.s
Minimum conductivity	20 $\mu$ S/cm
Process/Pipe connection & communication	
Process connection	<ul style="list-style-type: none"> <li>G 2" for use with Type S020 Insertion fitting</li> <li>Clamp for use with Type S020 Insertion fitting or any pipe equipped with our clamp sensor connection</li> </ul> <p>See <b>data sheet Type S020</b> ► for more information.</p>
Electrical connection	2 cable glands M20 $\times$ 1.5
User parameter	Saved in EEPROM

**Approvals and certificates**

**Directives**

CE directive	The applied standards, which verify conformity with the EU Directives, can be found on the EU Type Examination Certificate and/or the EU Declaration of conformity (if applicable).
Pressure equipment directive	Complying with article 4, paragraph 1 of 2014/68/EU directive Detailed information on the pressure equipment directive can be found in chapter <b>“2.2. Pressure equipment directive” on page 6.</b>

Certification Certificate	UL-Recognized for US and Canada <ul style="list-style-type: none"> <li>• FDA declaration of conformity (for stainless steel or PVDF sensor with FKM or EPDM seal)</li> <li>• ECR1935/2004 declaration (only for stainless steel sensor with EPDM seal)</li> </ul>
---------------------------	--

**Environment and installation**

Ambient temperature	<ul style="list-style-type: none"> <li>• Operation: -10...+60 °C (+14...+140 °F)</li> <li>• Storage: -20...+60 °C (-4...+140 °F)</li> </ul>
Relative air humidity	≤ 80 %, without condensation
Height above sea level	Max. 2000 m
Operating condition	Continuous
Equipment mobility	Fixed
Application range	Indoor and outdoor (protect the device against electromagnetic interference, ultraviolet rays and, when installed outdoors, against the effects of climatic conditions)
Degree of protection <sup>2.)</sup> according to IEC/EN 60529	IP65 under the following conditions: device wired, cover screwed tight and cable glands mounted and tightened or with blind plug if not used
Installation category	Category I according to UL/EN 61010-1
Pollution degree	Degree 2 according to UL/EN 61010-1

1.) Under reference conditions i.e. measuring fluid = water, ambient and water temperature = 20 °C (68 °F), while maintaining the minimum inlet and outlet distances and the appropriate internal diameters of the pipes.

2.) Not evaluated by UL

## 2. Approvals

### 2.1. Certifications

Certification	Description
	<b>UL-Recognized for USA and Canada</b> The products are UL-certified and also comply with the following standards: <ul style="list-style-type: none"> <li>• UL 61010-1</li> <li>• CAN/CSA-C22.2 No.61010-1</li> </ul>

### 2.2. Pressure equipment directive

The device conforms to article 4, paragraph 1 of the pressure equipment directive 2014/68/EU under the following conditions:

**Device used on a pipe**

**Note:**

- The data in the table is independent of the chemical compatibility of the material and the fluid.
- PS = maximum admissible pressure, DN = nominal diameter of the pipe

Type of fluid	Conditions
Fluid group 1, article 4, paragraph 1.c.i	DN ≤ 25
Fluid group 2, article 4, paragraph 1.c.i	DN ≤ 32 or PS*DN ≤ 1000
Fluid group 1, article 4, paragraph 1.c.ii	DN ≤ 25 or PS*DN ≤ 2000
Fluid group 2, article 4, paragraph 1.c.ii	DN ≤ 200 or PS ≤ 10 or PS*DN ≤ 5000

### 3. Materials

#### 3.1. Chemical Resistance Chart – Bürkert resistApp

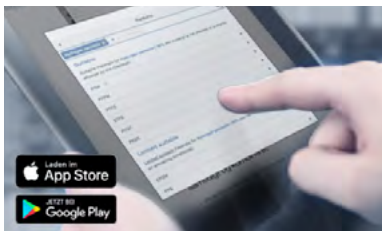

**Bürkert resistApp – Chemical Resistance Chart**

You want to ensure the reliability and durability of the materials in your individual application case? Verify your combination of media and materials on our website or in our resistApp.

[Start Chemical Resistance Check](#)

#### 3.2. Material specifications

Flowmeter with

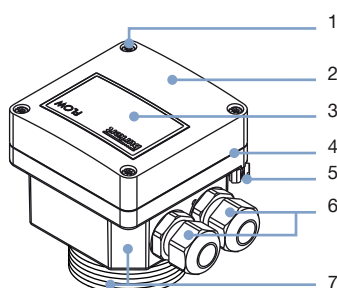

- G 2" process connection and sensor holder in PVDF or



- G 2" process connection and sensor holder in stainless steel or

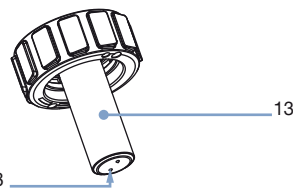

- Clamp process connection and with sensor holder in stainless steel

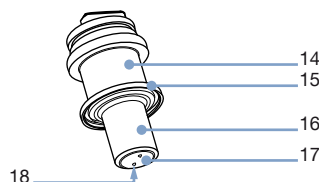

No.	Element	Material
1	Screws	Stainless steel
2	Cover	<ul style="list-style-type: none"> <li>PC for variant with flow sensor in PVDF</li> <li>Black PPA, glass fibre reinforced for variant with flow sensor in stainless steel</li> </ul>
3	Front panel foil	Polyester
4	Seal	NBR
5	Screw	Stainless steel
6	Cable glands	PA with neoprene seal
7	Housing	<ul style="list-style-type: none"> <li>PC, glass fibre reinforced for variant with flow sensor in PVDF</li> <li>Black PPA, glass fibre reinforced for variant with flow sensor in stainless steel</li> </ul>
8	Nut	<ul style="list-style-type: none"> <li>PC for variant with flow sensor in PVDF</li> <li>PPA glass fibre reinforced for variant with flow sensor in stainless steel</li> </ul>
9	Mounting ring (open)	Polysulphone, glass fibre reinforced
10	Seals	<ul style="list-style-type: none"> <li>FKM (approved FDA)</li> <li>EPDM included, but not mounted (conform to FDA)</li> </ul>
11	Sensor holder	PVDF
12	Earth ring	<ul style="list-style-type: none"> <li>Stainless steel 1.4404/316L or</li> <li>Alloy C22</li> </ul>
13	Sensor holder	Stainless steel 1.4404/316L
14	Holder	Stainless steel 1.4404/316L
15	Clamp	Stainless steel 1.4404/316L
16	Sensor holder	Stainless steel 1.4404/316L
17	Electrode holder	PEEK (conform to FDA)
18	Electrodes	<ul style="list-style-type: none"> <li>Stainless steel 1.4404/316L or</li> <li>Alloy C22</li> </ul>

DTS 1000021534 EN Version: V Status: RL (released | freigegeben | valide) printed: 04.01.2023

## 4. Dimensions

### 4.1. Flowmeter

With G 2" process connection

**Note:**

- Dimensions in mm, unless otherwise stated
- The length of the flow probe depends on the used Insertion fitting Type S020 and its nominal diameter.

See [data sheet Type S020](#) for more information or chapter "9.2. Combination of the device with available Type S020 Insertion fittings DN" on page 15.

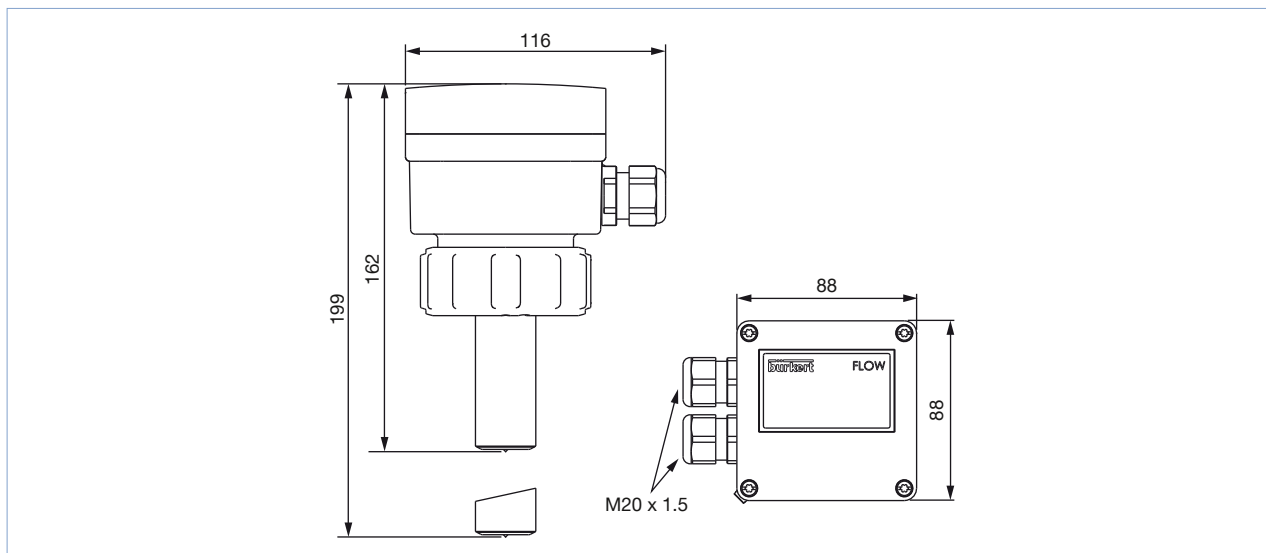

With clamp process connection

**Note:**

Dimensions in mm, unless otherwise stated

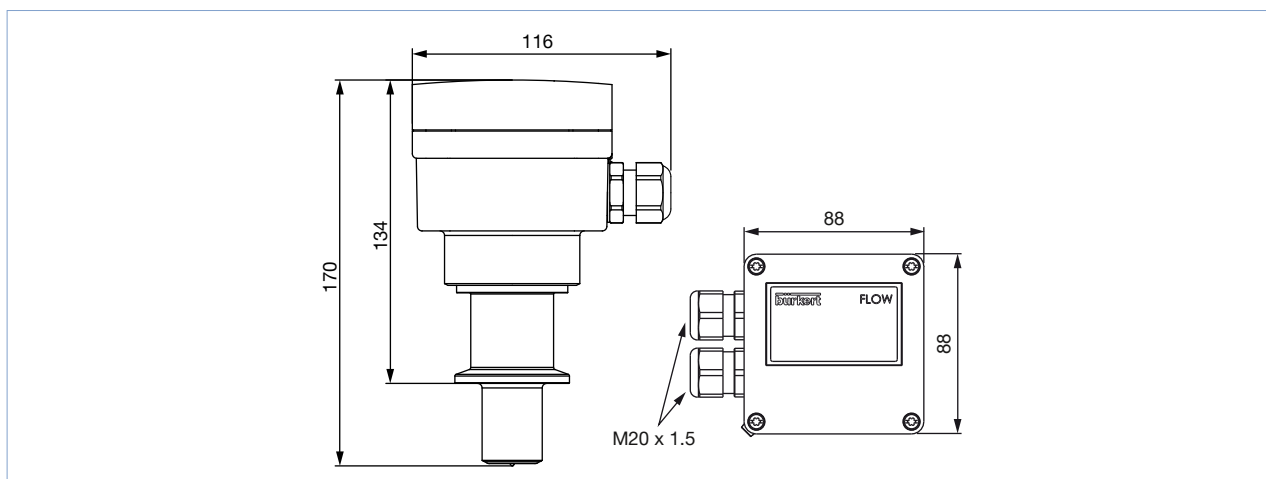



### 4.2. Flowmeter installed in a fitting Type S020

With G 2" process connection

**Note:**

Dimensions in mm, unless otherwise stated

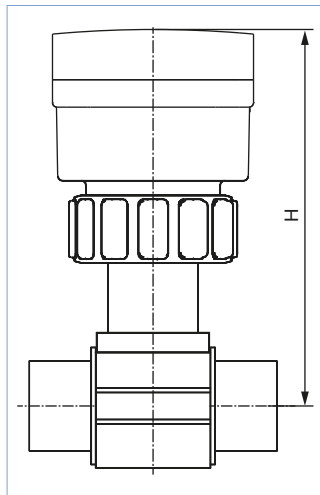

DN	H			
	T-Fitting	Saddle	Plastic spigot	Metal spigot
06	163	-	-	-
08	163	-	-	-
15	168	-	-	-
20	166	-	-	-
25	166	-	-	-
32	169	-	-	-
40	173	-	-	169
50	179	204	-	174
65	179	203	187	180
80	-	207	193	185
100	-	212	200	195
110	-	208	-	-
125	-	215	235	206
150	-	225	242	217
180	-	249	-	-
200	-	261	263	238
250	-	-	281	298
300	-	-	293	317
350	-	-	306	329
400	-	-	321	-

With clamp process connection

**Note:**

Dimensions in mm, unless otherwise stated

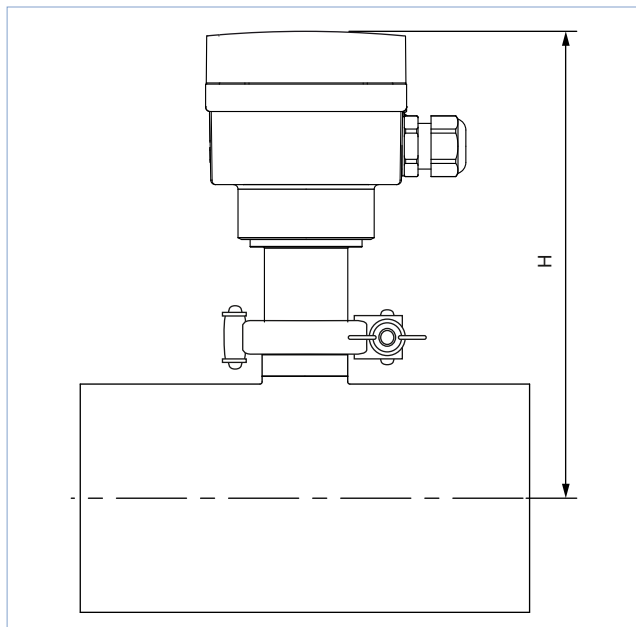

DN	H
	<b>T-Fitting</b>
32	181
40	186
50	191
65	199
80	205
100	211

DTS 1000021534 EN Version: V Status: RL (released | freigegeben | valide) printed: 04.01.2023

## 5. Performance specifications

### 5.1. Pressure temperature diagram

#### Flowmeter with a PVDF sensor

**Note:**

Please be aware of the fluid pressure/temperature dependence according to the respective fitting + flowmeter material as shown in the following diagram.

See [data sheet Type S020](#) ▶.

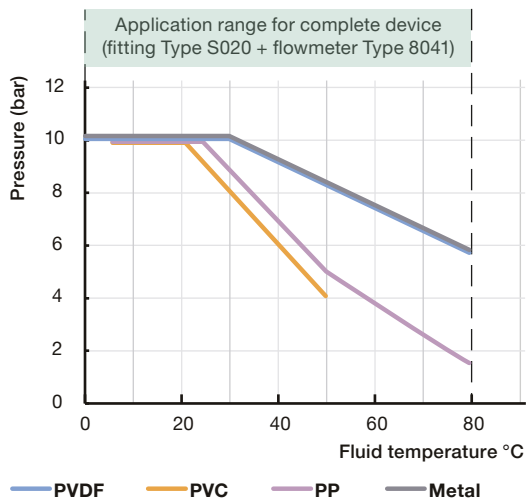

#### Flowmeter with a stainless steel sensor

**Note:**

Please be aware of the fluid pressure/temperature dependence according to the respective fitting + flowmeter material as shown in the following diagram.

See [data sheet Type S020](#) ▶.

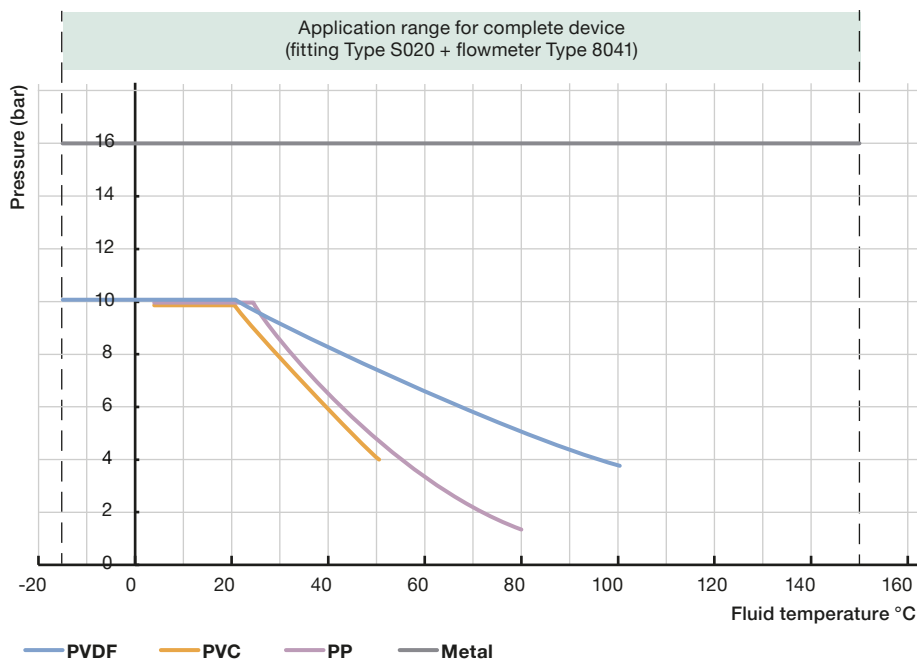

## 6. Product installation

### 6.1. Installation notes

**Note:**

The device is not suitable for use in gaseous media and steam.

Minimum straight upstream and downstream distances must be observed. According to the pipe's design, necessary distances can be bigger or use a flow conditioner to obtain the best accuracy.

For more information, please refer to EN ISO 5167-1.

EN ISO 5167-1 specifies the straight inlet and outlet distances that must be complied with when installing fittings in pipe lines in order to achieve calm flow conditions. The most important layouts that could lead to turbulence in the flow are shown below, together with the associated specified minimum inlet and outlet distances.

Make sure that the measuring conditions at the point of measurement are calm and problem-free.

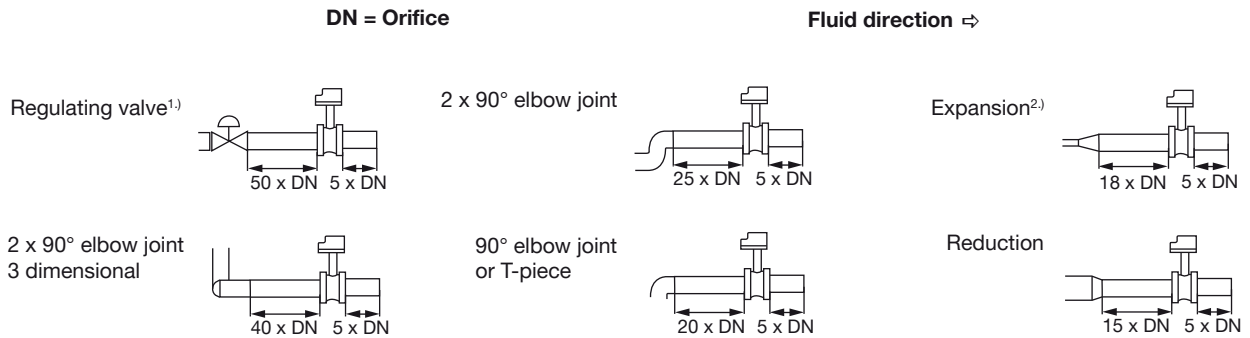

1.) If the valve cannot be mounted after the measuring device, the minimal distances have to be respected.

2.) If an expansion cannot be avoided, the minimal distances have to be respected.  
Please note minimum flow velocity

The flowmeter can be installed into either horizontal or vertical pipes.

Important criteria for this are; ensure that the measurement pipe is fully filled and that the measurement pipe is free of bubbles.

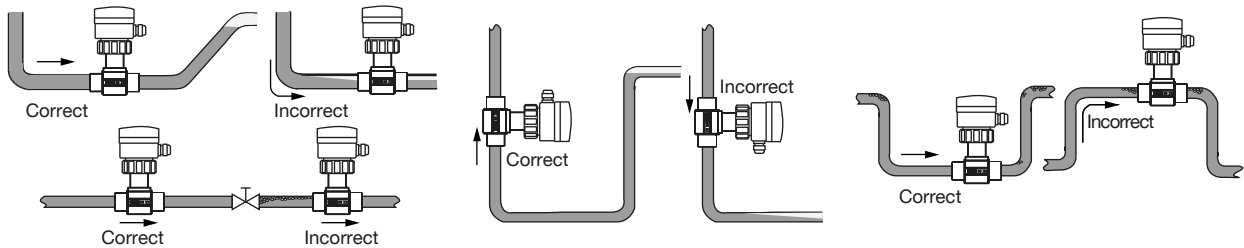

Pressure and temperature ratings must be respected according to the selected fitting material. The suitable pipe size is selected using the diagram for selecting the nominal diameter of the fitting, see **data sheet Type S020** ▶ for more information.

### 6.2. Mounting options

It is advisable to mount the flowmeter at a 45° angle to the horizontal centre of the pipe to avoid having deposits on the electrodes and false measurements due to air bubbles

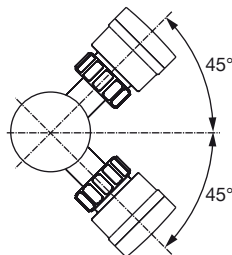

## 7. Product operation

### 7.1. Measuring principle

The E-shaped magnetic system inside the sensor induces a magnetic field into the fluid, which is perpendicular to the direction of flow. Two electrodes are in galvanic contact with the liquid.

Based on the Faraday law a voltage can be measured between these electrodes once a liquid (min. conductivity of 20  $\mu\text{S}/\text{cm}$ ) flows along the pipe. This voltage is proportional to the flow velocity.

Using the K-factor for the individual pipe diameter the speed of flow is converted into volume per time.

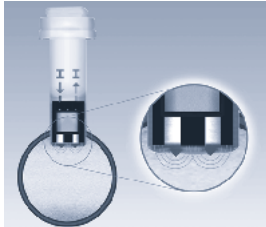

### 7.2. Functional overview

#### Display on the electronic board (PCB)

The settings needed for operation are made directly on the printed circuit board by means of 5 switches, a push button, a green LED, a red LED and a bar graph.

Electronic board of the device	No.	Description
	1	Terminal strip: <ul style="list-style-type: none"> <li>Operating voltage</li> <li>4...20 mA output</li> <li>Frequency output</li> </ul>
	2	Relay connection
	3	Push-button
	4	Green LED: <ul style="list-style-type: none"> <li>Flashing once every second: the device is energized</li> <li>Flashing once up to 5 times: to know which parameter the bargraph is indicating</li> </ul>
	5	Red LED: <ul style="list-style-type: none"> <li>Working mode (ON/OFF)</li> <li>Error signalling (flashing once up to 5 times)</li> </ul>
	6	10 LED bar graph to view and set the device parameters
	7	<ul style="list-style-type: none"> <li>Switches 1 to 5 to configure the flowmeter (mains frequency, filtering level of the measurements, measuring range)</li> <li>Switch 6: unused</li> </ul>

The device can be calibrated by means of the K-factor (conversion coefficient), or via the Teach-In function.

### Operating levels

The device has 2 operating levels:

- The Read level
- The Configuration level

Operating level	Functions
Read	Indication of <ul style="list-style-type: none"> <li>• the fluid velocity measured by the device.</li> <li>• the values set for the relay function.</li> </ul>
Configuration	<ul style="list-style-type: none"> <li>• Using as a flowmeter               <ul style="list-style-type: none"> <li>– Programming of the full scale</li> <li>– Selection of a predefined measuring range: 0...2, 0...5 or 0...10 m/s</li> <li>– Selection by Teach-In: with the actual max. flow velocity of the application</li> <li>– 4...20 mA current output</li> <li>– 0...240 Hz frequency output</li> <li>– Relay output: switching mode either window or hysteresis, on low or high switching threshold</li> <li>– Relay Time delay before switching</li> <li>– Filter</li> <li>– Alarm:                   <ul style="list-style-type: none"> <li>- For full scale exceeding with 22 mA and 256 Hz</li> <li>- For fault signalling with 22 mA and 0 Hz</li> </ul> </li> </ul> </li> <li>• Using as an ON/OFF control               <ul style="list-style-type: none"> <li>– Flow detection with switching thresholds, defined as a percentage of max. flow rate.</li> <li>– Adjustment of the full scale of the device accordingly to the customer process full scale.</li> </ul> </li> </ul>

## 8. Product design and assembly

### 8.1. Product assembly

**Note:**

- The device Type 8041 can easily be installed into any Bürkert Insertion fitting, Type S020, and fastened by means of a union nut.
- The Insertion fitting Type S020 ensures simple installation into pipes from DN 06...DN 400.

See **data sheet Type S020** ▶ for more information.

The device is equipped with a PVDF or stainless steel measurement sensor which comprises two electrodes and a magnetic system and is available in long or short variant (dependent on the size of the used fitting). The sensor holder is plugged-in to the housing, which contains containing the electronic module.

The connection of the device to the process is made depending on the variant, either by a G 2" nut or a clamp.

The electrical connection is provided via two cable glands on a 6 pin terminal block.

Compact flowmeter with a G 2" process connection



Insertion fitting with a G 2" sensor connection Type S020



Complete device with a G 2" process connection for flow measurement Type 8041

Fitting in stainless steel with a G 2" sensor connection Type S020 (only example)

Compact flowmeter with a clamp process connection

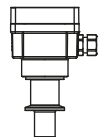

Clamp collar and seal (accessories, to be ordered separately)



Insertion fitting with a clamp sensor connection Type S020

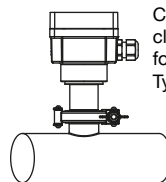
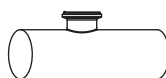

Complete device with a clamp process connection for flow measurement Type 8041

DTS 1000021534 EN Version: V Status: RL (released | freigegeben | valide) printed: 04.01.2023

## 9. Networking and combination with other Bürkert products

### 9.1. Networking and combination of the device

Example:

4...20 mA output	Relay output	Frequency output		
<b>Type 8802 ▶</b> (2301 & 8693) ELEMENT Continuous control valve systems	<b>Type 6281 ▶</b> Servo-assisted 2/2 way diaphragm valve	<b>Type 8619 ▶</b> multiCELL transmitter/controller panel- or wall-mounted	<b>Type 8025 ▶</b> Universal transmitter/ batch controller Wall-mounted or panel-mounted	<b>Type S020 ▶</b> Insertion fitting

### 9.2. Combination of the device with available Type S020 Insertion fittings DN

Fitting with G 2" process connection	DN06	DN08	DN32	DN50	DN65	DN100	DN200	DN350	DN400
T-fitting	1.)		short sensor						
Welding socket					short sensor		long sensor		
Fusion spigot					short sensor		long sensor		
Screw-on spigot						long sensor			
Saddle				long sensor					
<b>Fitting with clamp process connection</b>									
T-fitting or welding socket									

1.) DN06 and DN08: S020 in stainless steel only and 8041 with stainless steel sensor recommended

### 9.3. Remote transmitters Type 8025 which can be connected to the Type 8041 flowmeter

A remote electronic Type 8025 can be connected to the flowmeter Type 8041. For the selection of the article, see chapter [“Remote transmitters Type 8025 which can be connected to the Type 8041 flowmeter”](#) on page 18.

## 10. Ordering information

### 10.1. Bürkert eShop – Easy ordering and quick delivery



#### Bürkert eShop – Easy ordering and quick delivery

You want to find your desired Bürkert product or spare part quickly and order directly? Our online shop is available for you 24/7. Sign up and enjoy all the benefits.

[Order online now](#)

### 10.2. Recommendation regarding product selection

#### Flowmeter with G 2" process connection

A complete 8041 flowmeter consists of a 8041 flowmeter with G 2" process connection and a Bürkert S020 Insertion fitting with G 2" sensor connection .

See [data sheet Type S020](#) ▶ for more information.

Two different components must be ordered in order to select a complete device. The following information is required:

- **Article no.** of the desired compact flowmeter with G 2" process connection Type 8041 (see chapter "[Flowmeter with G 2" process connection](#)" on page 17)
- **Article no.** of the selected S020 Insertion fitting with G 2" sensor connection (see [data sheet Type S020](#) ▶)

#### Flowmeter with clamp process connection

A complete 8041 flowmeter consists of a 8041 flowmeter with clamp process connection and a Bürkert S020 Insertion fitting with clamp sensor connection .

See [data sheet Type S020](#) ▶ for more information.

Four different components must be ordered in order to select a complete device. The following information is required:

- **Article no.** of the desired flowmeter with clamp process connection Type 8041(see chapter "[Flowmeter with clamp process connection](#)" on page 17)
- **Article no.** of the selected S020 Insertion fitting with clamp sensor connection (see [data sheet Type S020](#) ▶)
- **Article no.** of the selected fitting/flowmeter seal, in EPDM or FEP (see chapter "[10.5. Ordering chart accessories](#)" on page 18)
- **Article no.** of the clamp collar (see chapter "[10.5. Ordering chart accessories](#)" on page 18)

### 10.3. Bürkert product filter



#### Bürkert product filter – Get quickly to the right product

You want to select products comfortably based on your technical requirements? Use the Bürkert product filter and find suitable articles for your application quickly and easily.

[Try out our product filter](#)



## 10.4. Ordering chart











### Flowmeter with G 2" process connection

**Note:**

The following variants

- have as minimum
  - a FKM process seal
  - an 18...36 V DC operating voltage
  - a relay
- are supplied with one kit 551775 (which contains an EPDM seal) and one relay connection kit 552812.

Detailed information regarding the kits can be found in chapter [“10.5. Ordering chart accessories”](#) on page 18.

Output	Material		Sensor variant	Certificate		UL certification	Electrical connection	Article no.
	Housing	Sensor / Earth ring / Electrode		FDA	ECR1935/2004 <sup>1)</sup>			
4...20 mA, frequency	PC	PVDF / Stainless steel / Stainless steel	Short	Yes	–	–	2 cable glands M20 x 1.5	558064 
			Long			UL-Recognized		570482 
		PVDF / Alloy C22 / Alloy C22	Short	–	–	558065 		
			Long		UL-Recognized	570483 		
	PPA	Stainless steel / – / Stainless steel	Short	Yes	Yes	–		560751 
			Long			UL-Recognized		560752 
			Short			UL-Recognized		552779 
			Long			–		561606 
					UL-Recognized	552780 		
					UL-Recognized	561607 		

1.) Only if the FKM seal mounted as standard at factory is replaced with the EPDM seal included in the delivery.

### Flowmeter with clamp process connection

**Note:**

The following variants

- have as minimum
  - an 18...36 V DC operating voltage
  - a relay
- are supplied with one Kit 565384 and one relay connection kit 552812.







Detailed information regarding the kits can be found in chapter [“10.5. Ordering chart accessories”](#) on page 18.

Output	Material			Certificate		Electrical connection	Article no.
	Housing	Sensor / electrode	Fitting/flowmeter seals <sup>1)</sup>	FDA	ECR1935/2004 <sup>2)</sup>		
4...20 mA, frequency	PC	Stainless steel / Stainless steel	EPDM or FEP	Yes	–	2 cable glands M20 x 1.5	564688 















1.) Has to be ordered separately.

2.) Only if mounted with EPDM seal.

## Remote transmitters Type 8025 which can be connected to the Type 8041 flowmeter

Description	Operating voltage	Output	Relays	Sensor variant	Electrical connection	Article no.
<b>Panel-mounted variant</b>						
"Universal", 2 totalizers	18...30 V DC	4...20 mA, pulse	–	8041	Terminal strip	419538 
			2			419537 
"Batch", 2 totalizers, 1 flowrate		–				419536 
<b>Wall-mounted variant</b>						
"Universal", 2 totalizers	18...30 V DC	4...20 mA, pulse	–	8041	3 cable glands	419541 
	115...230 V DC		2			419540 
			–			419544 
"Batch", 2 totalizers, 1 flowrate	18...30 V DC	–	2		5 cable glands	433740 

## 10.5. Ordering chart accessories

Description	Article no.
<b>For flowmeter with G 2" or clamp process connection</b>	
Set with 2 cable glands M20 × 1.5 + 2 neoprene flat seals for cable gland or plug + 2 screw plugs M20 × 1.5 + 2 multi-way seals 2 × 6 mm	449755 
Set with 2 reductions M20 × 1.5 /NPT ½" + 2 neoprene flat seals for cable gland or plug + 2 screw plugs M20 × 1.5	551782 
Relay connection kit with 1 screw terminal strip + 1 protection cap + 1 cable tie + 1 mounting instruction sheet	552812 
3 points flow calibration certificate <sup>1.)</sup>	550676 
FDA declaration of conformity <sup>2.)</sup>	803724 
<b>For flowmeter with G 2" process connection</b>	
Set with 1 stopper for unused cable gland M20 × 1.5 + 1 multiway seal 2 × 6 mm for cable gland + 1 green FKM seal for the sensor + 1 mounting instruction sheet	558102 
Set with a green FKM seal and a black EPDM seal	552111 
Fastening ring (open) for Type S020 Insertion fitting	619205 
PC union nut for Type S020 Insertion fitting	619204 
PPA union nut for Type S020 Insertion fitting	440229 
<b>For flowmeter with clamp process connection</b>	
Set with 1 stopper for unused cable gland M20 × 1.5 + 1 multiway seal 2 × 6 mm for cable gland	565384 
1 EPDM fitting/flowmeter seal	730837 
1 FEP fitting/flowmeter seal	730839 
Clamp collar	731164 

1.) Device combined with a fitting Type S020, only for DN ≤ 200

2.) For stainless steel or PVDF sensor with FKM or EPDM seal

# Bürkert – Close to You

For up-to-date addresses  
please visit us at  
[www.burkert.com](http://www.burkert.com)

DTS 1000021534 EN Version: V Status: RL (released | freigegeben | validé) printed: 04.01.2023

