



SAC 254 sensor

- UV absorption measurement at 254 nm
- Monitoring of dissolved organics in drinking water
- EDIP sensor: compatible with Type 8905/8906 measurement stations
- UV-LED technology for long-lasting sensors
- Nano-coated glasses to reduce maintenance

Product variants described in the data sheet may differ from the product presentation and description.

Can be combined with



Type 8905 ▶
Online Analysis System



Type 8920 ▶
Bürkert Communicator



Type 8923 ▶
USB-büS Interface Set

Type description

The Type MS08 sensor is an optical sensor for measuring absorption in the UV range at 254 nm. This sensor can be used to detect dissolved organic matter in the water and thus provide a high degree of safety for drinking water production.

The SAC 254 and turbidity 530 values can be measured, as well as an application-specific correlation of the TOCeq, BODEq and CODEq. The measurement principle is optical absorption measurement at 254 nm and 530 nm for turbidity compensation and is implemented using 2 LEDs and a detector.

The optical path length is optimized for drinking water, but can be easily adjusted by the manufacturer.

Table of contents

| | |
|---|----------|
| 1. General technical data | 3 |
| <hr/> | |
| 2. Materials | 5 |
| 2.1. Chemical Resistance Chart – Bürkert resistApp..... | 5 |
| 3. Dimensions | 5 |
| 3.1. Photometer installed into the measuring chamber (flow cell)..... | 5 |
| 3.2. büS interface..... | 6 |
| 4. Device/Process connections | 6 |
| 4.1. büS interface..... | 6 |
| Connection details..... | 6 |
| 5. Product installation | 7 |
| 5.1. Installation notes..... | 7 |
| 6. Product operation | 7 |
| 6.1. Measuring principle | 7 |
| 7. Product design and assembly | 8 |
| 7.1. Product assembly | 8 |
| 8. Product accessories | 8 |
| 8.1. Bürkert Communicator Software Type 8920 | 8 |
| 8.2. USB-büS Interface Set Type 8923..... | 9 |
| 9. Ordering information | 9 |
| 9.1. Bürkert eShop – Easy ordering and quick delivery..... | 9 |
| 9.2. Bürkert product filter | 9 |
| 9.3. Ordering chart..... | 9 |
| 9.4. Ordering chart accessories..... | 10 |

1. General technical data

The MS08 is a SAC 254 measuring system consisting of a photometer with 2 m cable with 8-pin M12 connector, a measuring chamber (flow cell) which allows a bypass installation, an büS interface, 3 cables of 1 m equipped with M12-connectors and a Y-splitter.

Product properties

Material

Please make sure the device materials are compatible with the fluid you are using.

Detailed information can be found in chapter **"2.1. Chemical Resistance Chart – Bürkert resistApp"** on page 5.

| | |
|---------------------------|---|
| Photometer | Housing in stainless steel (1.4571/1.4404) |
| Flow cell | <ul style="list-style-type: none"> Housing in POM Seal in NBR Screw in stainless steel 316 (A4) |
| büS interface | <ul style="list-style-type: none"> Front side housing in PC (Polycarbonate) Rear side housing in polyurethane potting resin, natural |
| Fixed connector and cable | <ul style="list-style-type: none"> Cable in PUR Screw connection in Zinc die casting, matte nickel-plated |
| Compatibility | With Online Analysis System Type 8905 Detailed information can be found in the data sheet of the online analysis system, see data sheet Type 8905 ▶ for more information. |

Dimensions

Detailed information can be found in chapter **"3. Dimensions"** on page 5.

| | |
|---------------|---|
| Photometer | 333 x 48.3 mm (L x Ø) with a 50 mm path |
| Flow cell | 150 x 65 x 65 mm |
| büS interface | 210 x 65 x 18 mm |

Weight

| | |
|------------------------|---|
| Photometer | Approx. 2.3 kg |
| Flow cell | Approx. 0.8 kg |
| büS interface | Approx. 0.4 kg |
| Measurement technology | Photometry <ul style="list-style-type: none"> Light source: 2 LED (254 nm, 530 nm) Detector: photodiode |

| | |
|---------------------|---------------------------|
| Measuring principle | Attenuation, transmission |
|---------------------|---------------------------|

| | |
|--------------|---------------------------|
| Optical path | 50 mm (others on request) |
|--------------|---------------------------|

| | |
|-------------------|---|
| Measured quantity | <ul style="list-style-type: none"> SAC₂₅₄ (Spectral Absorption Coefficient) COD_{eq} BOD_{eq} TOC_{eq} Turb₅₃₀ |
|-------------------|---|

| | |
|------------------------|---------------------|
| Measuring range | With 50 mm path |
| SAC ₂₅₄ | 0.10...30 1/m |
| COD _{eq} | 0.15...45 mg/l |
| BOD _{eq} | 0.05...15 mg/l |
| TOC _{eq} | 0.06...20 mg/l |
| Turb ₅₃₀ | 0.4...40 FAU |
| Compensation | Turbidity at 530 nm |

Data-logger

| | |
|---------------|--|
| büS interface | Micro SD card (not included in delivery), for storage of device parameters, configuration and for easy replacement of photometer |
|---------------|--|

| | |
|-------------|---|
| Maintenance | Calibration/maintenance interval: 24 months |
|-------------|---|

Performance data

SAC measurement

| | |
|-----------------------------------|---------------------|
| Measurement deviation | 0.2 % of full scale |
| Measurement interval | ≥ 10 s |
| Response time (t ₁₀₀) | 10 s |

Electrical data

Operating voltage

| | |
|---------------|---|
| Photometer | 24 V DC \pm 10 % (through connector X8 of büS interface) |
| büS interface | 24 V DC \pm 10 % - residual ripple 10 % ^{1.)} (through connector X4 connected to Online Analysis System Type 8905. Detailed information can be found in the data sheet of the online analysis system, see data sheet Type 8905 ► for more information.) |

Power consumption

| | |
|---------------|------------------------------|
| Photometer | \leq 1 W |
| büS interface | \leq 2 W (of module alone) |

Current

| | |
|---------------|--|
| büS interface | <ul style="list-style-type: none"> Max. input current: 4 A for supply via X4 (M12, A-coded, plug) Max. output current: 4 A in total with supply via X4 |
|---------------|--|

Output

| | |
|---------------|-------------------|
| Photometer | Ethernet (TCP/IP) |
| büS interface | Bürkert büS |

Medium data

| | |
|-------------------------------------|--|
| Fluid | Water without particles: drinking water, industrial water |
| Temperature of the fluid sample | +2...+40 °C (+36...+104 °F) |
| Pressure of the fluid sample | <ul style="list-style-type: none"> Photometer alone: 3 bar With flow cell: \leq 1 bar |
| Flow rate of the fluid sample | With flow cell: 2...4 l/min |
| Inflow velocity of the fluid sample | 0.1...10 m/s (0.33...33 fps) |

Process/Pipe connection & communication

| | |
|-----------------------|--|
| Process connection | Hose connections of flow cell (6 or 8-mm inlet, 6-mm outlet) |
| Electrical connection | M12 male plug, A-coded (X4 (IN)) of büS interface |

Data transfer

| | |
|------------------------|--|
| External communication | <ul style="list-style-type: none"> Through büS (Bürkert system bus, CANopen protocol) By status LED: with RGB-LED based on NAMUR NE 107 on the büS interface |
|------------------------|--|

Approvals and Certificates

Directives

| | |
|--------------|---|
| CE directive | The applied standards, which verify conformity with the EU Directives, can be found on the EU Type Examination Certificate and/or the EU Declaration of conformity (if applicable). |
|--------------|---|

Environment and installation

Ambient temperature

| | |
|------------------------|---|
| Photometer | <ul style="list-style-type: none"> Operation: +2...+40 °C (+36...+104 °F) Storage: -20...+80 °C (-4...+176 °F) |
| büS interface | <ul style="list-style-type: none"> Operation: -20...60 °C (-4...+140 °F) Storage: -20...70 °C (-4...+158 °F) |
| Relative air humidity | \leq 90 %, without condensation |
| Height above sea level | Max. 2000 m |
| Operating condition | Continuous |
| Equipment mobility | Fixed |
| Application range | Indoor and outdoor (protect the device against electromagnetic interference, ultraviolet rays and, when installed outdoors, against the effects of climatic conditions) |

Degree of protection

| | |
|-----------------------|---|
| Photometer | IP68 according to IEC/EN 60529, NEMA 6P |
| büS interface | IP65, IP67 and IP69k according to EN/IEC 60529 (with cables connected and with protective caps on unused connections) |
| Cable | IP65, IP67 according to EN/IEC 60529 |
| Installation category | Category I according to UL/EN 61010-1 |
| Pollution degree | Degree 2 according to UL/EN 61010-1 |

1.) The requirements of the attached components need to be considered in the selection of the power supply as well.

2. Materials

2.1. Chemical Resistance Chart – Bürkert resistApp

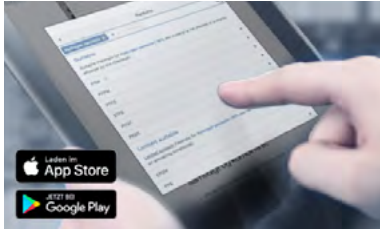

Bürkert resistApp – Chemical Resistance Chart

You want to ensure the reliability and durability of the materials in your individual application case? Verify your combination of media and materials on our website or in our resistApp.

[Start Chemical Resistance Check](#)

3. Dimensions

3.1. Photometer installed into the measuring chamber (flow cell)

Note:

Dimensions in mm, unless otherwise stated

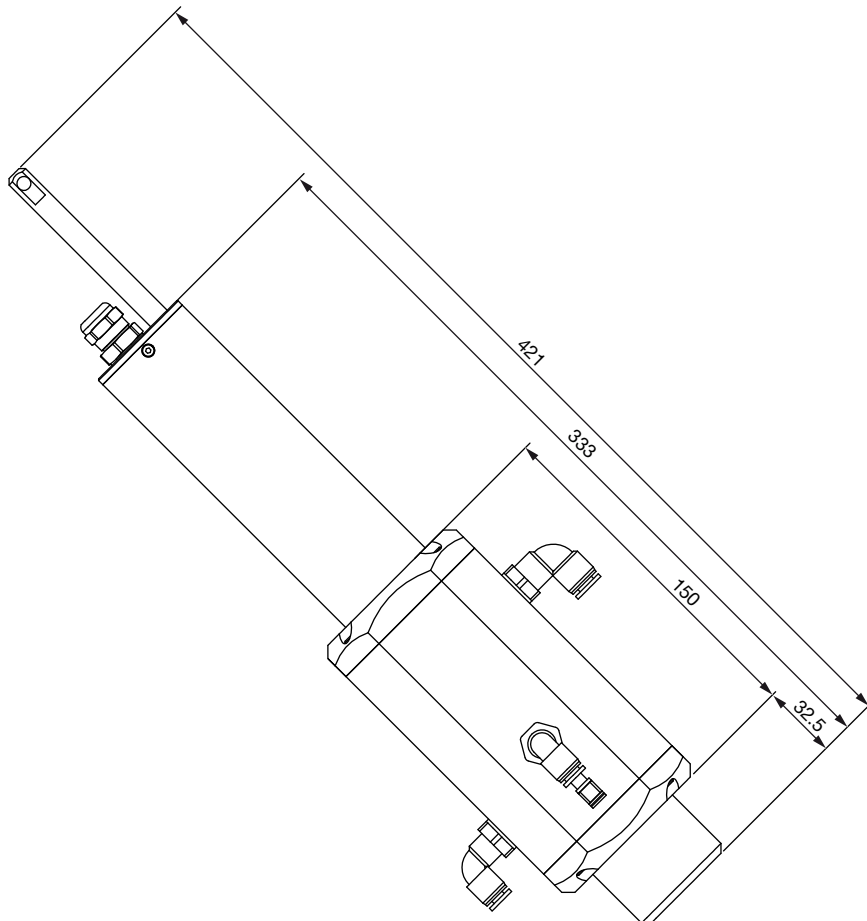

3.2. bÜS interface

Note:

Dimensions in mm, unless otherwise stated

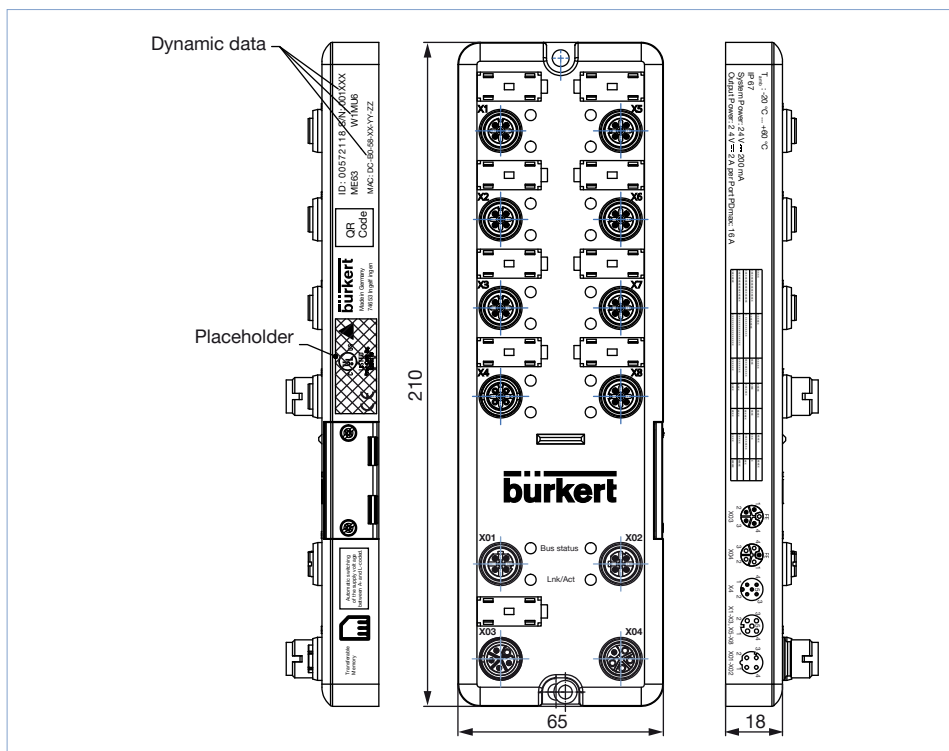

4. Device/Process connections

4.1. bÜS interface

Connection details

Note:

Device automatically detects whether the power supply is connected to X4.

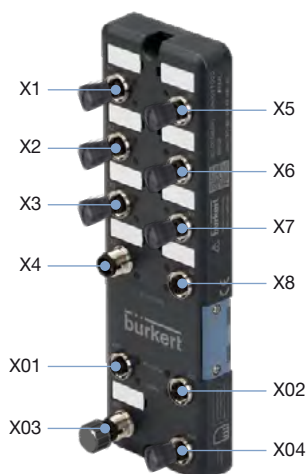

| No. | Description |
|-----|--|
| X1 | M12-A, socket, not used |
| X2 | M12-A, socket, not used |
| X3 | M12-A, socket, not used |
| X4 | M12-A, plug, Power IN 24 V DC, max. 4 A and bÜS/CANopen |
| X5 | M12-A, socket, not used |
| X6 | M12-A, socket, not used |
| X7 | M12-A, terminating resistor 120 Ω, if necessary |
| X8 | M12-A, socket, Power OUT 24 V DC, max. 4 A, to power the photometer |
| X01 | M12-D, socket, not used |
| X02 | M12-D, socket, Ethernet, e.g. for Ethernet integration of the photometer |
| X03 | M12-L, plug, not used |
| X04 | M12-L, socket, not used |

DTS 1000529163 EN Version: C Status: RL (released | freigegeben | validé) printed: 14.07.2023

5. Product installation

5.1. Installation notes

The SAC 254 measuring system is designed for use with the online analysis system, Type 8905. It is simply connected via a cable to Type 8905. But it is also possible to connect the SAC 254 measuring system to a PC with the Bürkert Communicator Software Type 8920 with help of the USB-büS Interface Set Type 8923.

See [data sheet Type 8905](#) ▶ Online Analysis System, [software manual Type 8920](#) ▶ or chapter [“8.2. USB-büS Interface Set Type 8923”](#) on [page 9](#) for more information.

6. Product operation

6.1. Measuring principle

Note:

For optimal use of the sensor, it is essential to understand the measuring principle and measurement setup which the sensor is based on. The following is an overview of the measurement principle, the optical arrangement and the subsequent calculation.

The photometer essentially consists of four parts: a defined light source, a lens system, the optical path through the medium and a detector with ambient light suppression. The arrangement of these parts is represented schematically in the following illustration.



The light source consists of two LEDs of different wavelengths. The wavelength of the first LED (LED 1) is 254 nm. The wavelength of the second LED (LED 2) is 530 nm. This wavelength is used for turbidity correction. The light emitted by the LEDs passes through the medium on the way to the detector and is partially weakened by the medium. The detector picks up the remaining light and thus determines its intensity “I”. The weakening of the light when passing through the measurement medium is compared to the weakening caused by ultra-pure water. The measurement in ultra-pure water provides the so-called basic intensity “I₀”. Using the equation, the photometer determines the transmission T (=I/I₀) and the absorbance A (=–log₁₀T) of both of the above-mentioned wavelengths.

The light intensity of LEDs often varies with the temperature. Therefore, a temperature correction factor is determined for each wavelength of the photometer and is used to calculate the measurement value.

The photometer outputs the SAC of the wavelength of LED 1 at 254 nm. This is referred to as SAC₂₅₄ in the following. Accordingly, the absorption at the wavelength of LED 1 will be denoted with A₂₅₄. Scattering of light on particles in a solution is seen as turbidity by the observer. The photometer uses the absorbance of 530 nm (A₅₃₀) for the turbidity correction of the absorption measurement of the wavelength emitted by LED 1 (A₂₅₄). The SAC₂₅₄ (spectral absorption coefficient in [1/m]) is calculated using the equation = (A₂₅₄–A₅₃₀)·1000/d where d is the length of the optical path in millimeters (50 mm for the MS08 measuring system).

7. Product design and assembly

7.1. Product assembly

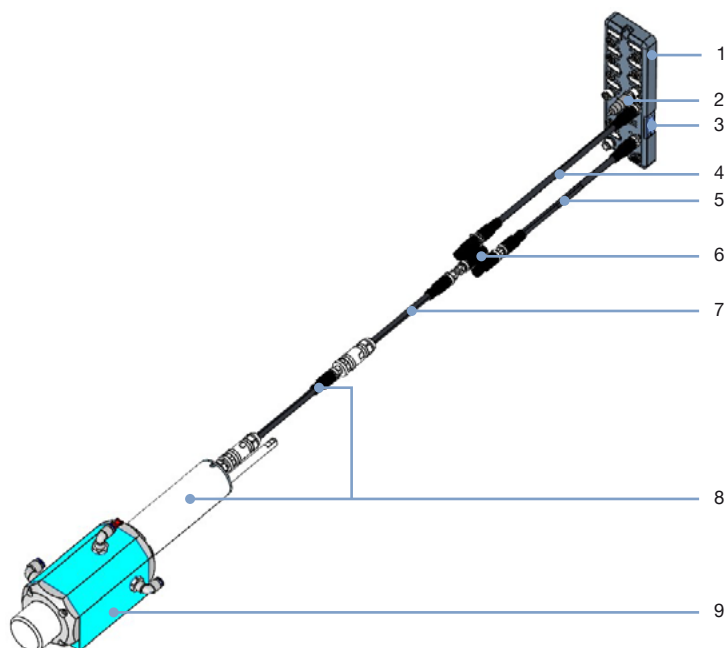

| No. | Element |
|-----|--|
| 1 | büS interface |
| 2 | Terminating resistor 120 Ω , if needed |
| 3 | Micro SD card for saving device specific settings |
| 4 | büS/CANopen shielded cable, 1 m length, with 5-pin M12 male and 5-pin M12 female connectors |
| 5 | Ethernet shielded cable, 1 m length, with two 4-pin M12 male connectors |
| 6 | Shielded Y-splitter with 8-pin M12 female connector Y-coding + 4-pin M12 female connector D-coding + 5-pin M12 male connector A-coding |
| 7 | Adaptation shielded cable, 1 m length, with 8-pin M12 male and female connectors |
| 8 | Photometer with connection cable, 2 m length, with 8-pin M12 female connector A-coding |
| 9 | Measuring chamber (flow cell) |

8. Product accessories

8.1. Bürkert Communicator Software Type 8920

Part of Bürkert's new EDIP program (Efficient Device Integration Platform) is the Bürkert Communicator. This software can be run under MS-Windows and it is available on Bürkert's website for free.

To install the software, click [here](#) ►.

The Bürkert Communicator allows convenient system configuration and parametrisation of all connected field devices. An accessory part, the büS stick serves as the interface between computer and process instruments (see "9.4. Ordering chart accessories" on page 10). The Communicator allows:

- Diagnostics
- Parametrization
- Registration and storage of process data
- Graphical monitoring of the process data
- To update firmware of the büS device connected
- Guided re-calibration

8.2. USB-büS Interface Set Type 8923

See “9.4. Ordering chart accessories” on page 10 for ordering information.

| Accessories | No. | Description |
|-------------|-----|---|
| | 1 | Quick-Start |
| | 2 | Power supply: 100...240 V AC/ 24 V DC 1 A and adaptors for power supply worldwide use |
| | 3 | büS terminating resistor on büS Y-splitter |
| | 4 | 5-pin M12 circular male connector wired on free end cable |
| | 5 | büS connection cable with 5-pin M12 circular male connector, micro USB B plug |
| | 6 | büS adapter with 5-pin M12 circular male connector, A-coded to 5-pin M12 circular male connector, A-coded |
| | 7 | büS stick (USB to büS/CANopen adaptor) |
| | 8 | büS service cable with 5-pin M12 circular female connector, mini USB and circular plug-in connectors for power supply |
| | 9 | Magnetic key |
| | 10 | CD - Communicator (30-day license without registration, update and licensing over Bürkert home page) |

9. Ordering information

9.1. Bürkert eShop – Easy ordering and quick delivery



Bürkert eShop – Easy ordering and quick delivery

You want to find your desired Bürkert product or spare part quickly and order directly? Our online shop is available for you 24/7. Sign up and enjoy all the benefits.

[Order online now](#)

9.2. Bürkert product filter

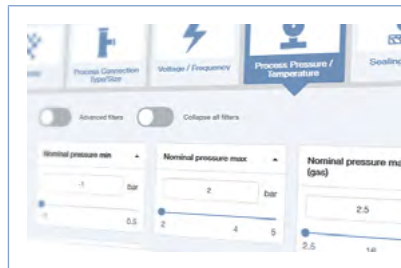

Bürkert product filter – Get quickly to the right product

You want to select products comfortably based on your technical requirements? Use the Bürkert product filter and find suitable articles for your application quickly and easily.







































[Try out our product filter](#)

9.3. Ordering chart

| Description | Article no. |
|--|-------------|
| SAC 254 measuring system (photometer + measuring chamber (flow cell) + büS interface + cables) | 572112 |

| Further versions on request | |
|-----------------------------|---|
| | Additional SAC 254 measurement: other possible measuring ranges |

9.4. Ordering chart accessories

| Description | | Article no. | |
|--|---|--|--|
| SAC 254 photometer | | 572114  | |
| Measuring chamber (flow cell) | | 572116  | |
| bÜS interface | | 572118  | |
| Micro SD card | | 774087  | |
| Fluidic accessories | | | |
| Sample water pipe 4/6 mm | 5 m | 567793  | |
| | 10 m | 567701  | |
| | 25 m | 567794  | |
| Hose connector angle, ¼" pipe 4/6 mm | | 782348  | |
| Strainer 100 µm | | 772703  | |
| Pressure reducer | | 772437  | |
| Bubble trap | | 568492  | |
| Set with a pressure reducer (including a 100 µm strainer, a sampling point and two G ¼" connections), a wall-mounting bracket with nut (for the pressure reducer), a pressure gauge (for the pressure reducer) and two quick-connect couplings | | 566319  | |
| Filter housing made of plastic with NBR seal for filter element 50 µm, inlet and outlet ¼" | | 774292  | |
| Filter housing made of plastic with NBR seal for filter element 90 µm or 140 µm, inlet and outlet ¼" | | 774287  | |
| Filter element | 50 µm | 774293  | |
| | 90 µm | 774290  | |
| | 140 µm | 774291  | |
| Type MZ20 cleaning system, 2 solutions See data sheet Type MZ20  Cleaning System for more information. | | 567124  | |
| Cleaning set for optical | | 574346  | |
|  | Calibration set | 574344  | |
| | | 574345  | |
| Interface accessories | | | |
| bÜS Stick Set | | | |
|  | USB-bÜS-Interface Set 1, Type 8923 Detailed information can be found in chapter "8.2. USB-bÜS Interface Set Type 8923" on page 9. | 772426  | |
| USB-bÜS Interface Set 2, Type 8923 (only bÜS Stick, cable and bÜS service cable) | | 772551  | |
| Connectors and sockets | | | |
| bÜS Y-distributor, 5-pin M12 circular female connector to 5-pin M12 circular male and 5-pin M12 circular connectors | | 772420  | |
| bÜS Y-distributor, 5-pin M12 circular female connector to 5-pin M12 circular male and 5-pin M12 circular connectors (power interrupt) | | 772421  | |
| bÜS adaptor M12 circular male connector A-coded - M12 circular male connector A-coded | | 772867  | |
| bÜS termination, 5-pin M12 circular male connector | | 772424  | |
| bÜS termination, 5-pin M12 circular female connector | | 772425  | |
| Extensions | | | |
|  | 5-pin M12 straight circular female and male connectors moulded on bÜS cable, shielded | 0.5 m | 772403  |
| | | 1 m | 772404  |
| | | 3 m | 772405  |
| | | 5 m | 772406  |
| | | 10 m | 772407  |
| | | 20 m | 772408  |
| Software | | | |
| Software Bürkert Communicator | | Download Type 8920  | |

Bürkert – Close to You

For up-to-date addresses
please visit us at
www.burkert.com

DTS 1000529163 EN Version: C Status: RL (released | freigegeben | validé) printed: 14.07.2023

