



Transmitters for electromagnetic inductive flow sensors

- Must be combined with sensor Type S051, S054, S055 or S056
- Continuous measurement, high accuracy
- Different housing shapes and materials available
- Compact and remote design selectable, available with or without display

Product variants described in the data sheet may differ from the product presentation and description.

Can be combined with

	Type S051 ▶ Magnetic inductive flow sensor, low flow rates
	Type S054 ▶ Magnetic inductive sensor without flange (wafer connection)
	Type S055 ▶ Magnetic inductive sensor with flange
	Type S056 ▶ Magnetic inductive sensor with hygienic process connections

Type description

The Type SE58 transmitter (in S, M or L variant) associated with the electromagnetic flow sensor (in compact or remote variant) Type S051, S054, S055 or S056 is designed for applications with a minimum conductivity of 5 $\mu\text{S}/\text{cm}$.

- **SE58 S:**
This variant of transmitter can only be used to build a compact variant of a flowmeter version, with or without display. It is characterised by small external dimensions and:
 - for a variant without display, by a housing and cover in black painted aluminium or stainless steel,
 - for a variant with display, by a black painted aluminium or stainless steel housing and a plastic cover.
 The display is integrated in the cover. Flow rate and totalizer values are displayed simultaneously, as well as symbols for device status and alarms. The flow rate measurement can be transferred via a digital or an analogue output. The achievable uncertainty is 0.5 % of the measured value. The device cannot be improved with the addition of input/output signals and functionalities such as dosing.
- **SE58 M and SE58 L:**
These variants of transmitters, with painted aluminium, plastic or stainless steel housings, are available to build a compact or remote variant of a flowmeter, with or without display. The device can be improved with the addition of input/output signals and functionalities such as dosing (only SE58 L) and data logger. The Human Machine Interface (HMI) comprising the display and the operating keys allows the choice of flexible data presentations, the carrying out of complete settings and the configuration of the device. The L variant is characterized by superior performance as shown by the low uncertainty of 0.2% of the measured value compared to 0.4% (option) and 0.8% with the M variant.

Table of contents

1. General technical data	3
1.1. About the device.....	3
1.2. SE58 L transmitter	3
1.3. SE58 M transmitter	5
1.4. SE58 S transmitter	7
2. Dimensions	9
2.1. SE58 L and SE58 M transmitter.....	9
Compact variant with housing in aluminium or reinforced nylon.....	9
Remote variant with housing in aluminium or reinforced nylon	10
Compact and remote variants with housing in stainless steel.....	11
2.2. SE58 S transmitter	12
3. Performance specifications	13
3.1. Measurement deviation diagram.....	13
SE58 L transmitter	13
SE58 M transmitter	13
SE58 S transmitter	14
3.2. Default configuration.....	14
4. Product operation	15
5. Product accessories	16
6. Networking and combination with other Bürkert products	17
6.1. Compact variant.....	17
6.2. Remote variant.....	18
7. Ordering information	19
7.1. Bürkert eShop.....	19
7.2. Recommendation regarding product selection.....	19
7.3. Bürkert product filter	19
7.4. Ordering chart	20
SE58 L transmitter	20
SE58 M transmitter	21
SE58 S transmitter	22
7.5. Ordering chart accessories.....	22

1. General technical data

1.1. About the device

The SE58 transmitter is available in three versions:

- SE58 L available with an aluminium, plastic or stainless steel housing and cable glands, with or without display, compact or remote design
- SE58 M available with an aluminium, plastic or stainless steel housing and cable glands, with or without display, compact or remote design
- SE58 S available with an aluminium or stainless steel housing, M12 connector or one cable gland with connected cable and with or without display, no remote variant



Settings for SE58 L and SE58 M can be done using the operator keys or by USB cable and PC tool MCP. However, any changes using MCP are not recommended, unless:

- after receiving corresponding training by Burkert,
- done by professional,
- agreed by the end user, and
- done inline with the MCP manual.

All transmitters are intended for use with electromagnetic flow sensors Type S051, S054, S055 or S056.

Detailed information can be found in the data sheets of the electromagnetic-inductive flow sensors, see [data sheet Type S051](#) ▶, [data sheet Type S054](#) ▶, [data sheet Type S055](#) ▶, [data sheet Type S056](#) ▶.

1.2. SE58 L transmitter



Product properties	
Material	
Lid	PC
Front panel film	Polyester
Deckel	<ul style="list-style-type: none"> • Painted aluminium die casting or • Nylon reinforced (PA6) with 15 % of glass fibre or • Stainless steel 304 (1.4301) electro-polished
Housing	<ul style="list-style-type: none"> • Painted aluminium die casting or • Nylon reinforced (PA6) with 15 % of glass fibre or • Stainless steel 304 (1.4301) electro-polished
Seal	Silicone
Cable gland	PA
Display	Graphic display 8 lines x 16 characters, 128 x 64 pixels with back light
Keypad	3 operating keys
Compatibility	Electromagnetic flow sensors Type S051, S054, S055, S056 in compact or remote variant Detailed information can be found in data sheets, see data sheet Type S051 ▶, data sheet Type S054 ▶, data sheet Type S055 ▶, data sheet Type S056 ▶.

Dimensions	Detailed information can be found in chapter "2. Dimensions" on page 9.
Data-logger	A Micro-SD memory card 4 GBytes stores the selected data in a specified interval (option)
Special function	<ul style="list-style-type: none"> • Bidirectional measure • Dual measurement range • Diagnostic functions such as device self tests and process diagnostics like empty-pipe^{1,3} or measurement value limit detection • Batch filling functions

Performance data

At reference conditions and according to internal test procedures:

- At room temperature
- Constant flow rate during the test, liquid speed > 1 m/s
- Pressure: >30 Kpa
- Flow condition: observed inlet and outlet conditions
- Zero point stability: $\pm 0.005\%$
- Default configuration if ordered together with sensor Type S051, S054, S055, S056. Detailed information can be found in chapter **"3.2. Default configuration"** on page 14.

Measurement deviation	$\leq \pm 0.2\%$ of the measured value for flow velocity > 0.5 m/s Detailed information can be found in chapter "3.1. Measurement deviation diagram" on page 13.
Repeatability	$\leq \pm 0.1\%$ of the measured value for flow velocity > 0.5 m/s
Response time	Minimum time <ul style="list-style-type: none"> • for analogue output (AO), when damping setting is deactivated and according to sensor size: <ul style="list-style-type: none"> – DN 03...DN 250: 20 ms – DN 300...DN 400: 100 ms • for digital output: <ul style="list-style-type: none"> – 100 ms (if used with the sensor Type S054 or Type S055) – 20 ms (if used with the sensor Type S051 or Type S056)

Electrical data

Operating voltage	<ul style="list-style-type: none"> • 100...240 V AC, 44 Hz...66 Hz • 12...48 V DC • Others on request
Power consumption	Max. 20 VA with 100...240 V AC operating voltage
Input	1 digital, function use is configurable (e.g. Totalizer reset)
Output	<ul style="list-style-type: none"> • Transistor: 2 digital outputs (DO), both with open collector configurable as <ul style="list-style-type: none"> – pulse/frequency (1250 Hz, max. 100 mA, 30 V DC) or – alarm/batch (adjustable usage) • Current: <ul style="list-style-type: none"> – max. 2 analogue outputs (AO), 0/4...20/22 mA, RL = 1000 Ω – HART (optional) only over first analogue output • Serial interface (optional): RS-485 (available with Modbus protocol (option))
Galvanic isolation	All the input/outputs are galvanically isolated up to 250 V from operating voltage
Protection class	Class I
Connection cable	Between sensor and transmitter: <ul style="list-style-type: none"> • Cable C015/C016 for remote variant • 10 m (other lengths on request) Detailed information can be found in data sheets, see data sheet Type S051 ▶, data sheet Type S054 ▶, data sheet Type S055 ▶, data sheet Type S056 ▶.

Medium data

Velocity range	0.4...10 m/s
Minimum conductivity	5 $\mu\text{S/cm}$

Connections & communication

Electrical connection	<ul style="list-style-type: none"> • 5 cable glands PG11 for aluminium or nylon housing or • 6 cable glands PG11 for stainless steel housing
-----------------------	--

Plug for configuration connection	USB port for the connection to PC (USB cable with USB mini B and USB type A connectors is required for the configuration and parameter settings)
Industrial communication	<ul style="list-style-type: none"> • RS-485 • Wi-Fi (as alternative for remote device configuration)
Protocol	<ul style="list-style-type: none"> • Modbus over RS-485 • HART (available on first analogue output)

Approvals and certificates

Directives

CE directive The applied standards, which verify conformity with the EU Directives, can be found on the EU Type Examination Certificate and/or the EU Declaration of conformity (if applicable).

Environment and installation

Ambient temperature	<p>Operation and storage</p> <ul style="list-style-type: none"> • Aluminium or stainless steel housing: -20...+60 °C (-4...+140 °F) • Reinforced nylon housing: -10...+50 °C (+14...+122 °F)
Relative air humidity	0...100 %, without condensation
Height above sea level	-200...+4000 m
Operating condition	Continuous
Equipment mobility	Fixed device
Application range	Indoor and outdoor (protect the device against electromagnetic interference, ultraviolet rays and against the effects of climatic conditions)
Degree of protection according to IEC/EN 60529	<ul style="list-style-type: none"> • Aluminium housing: IP65, IP67 (IP 68 option) • Reinforced nylon housing: IP65, IP67 • Stainless steel housing: IP65
Installation category	Category II according to UL/EN 61010-1
Pollution degree	Degree 2 according to UL/EN 61010-1

1.) Empty pipe functionality is not available if sensors are selected in the range of DN 03 to DN 20.

1.3. SE58 M transmitter



Product properties

Material

Lid	PA
Front panel film	Polyester
Cover	<ul style="list-style-type: none"> • Painted aluminium die casting or • Nylon reinforced (PA6) with 15 % of glass fibre or • Stainless steel 304 (1.4301) electro-polished
Housing	<ul style="list-style-type: none"> • Painted aluminium die casting or • Nylon reinforced (PA6) with 15 % of glass fibre or • Stainless steel 304 (1.4301) electro-polished
Seal	Silicone
Cable gland	PA
Display	Graphic display 8 lines x 16 characters, 128 x 64 pixels with back light
Keypad	3 operator keys
Compatibility	Electromagnetic flow sensors Type S051, S054, S055, S056 in compact or remote variant Detailed information can be found in data sheets, see data sheet Type S051 ▶, data sheet Type S054 ▶, data sheet Type S055 ▶, data sheet Type S056 ▶.
Dimensions	Detailed information can be found in chapter " 2. Dimensions " on page 9 .
Data-logger	A Micro-SD memory card 4 GBytes stores the selected data in a specified interval (option)

Special function	<ul style="list-style-type: none"> • Bidirectional measure • Dual measurement range • Diagnostic functions such as device self tests and process diagnostics like empty-pipe¹⁾ or measurement value limit detection
------------------	---

Performance data

At reference conditions and according to internal test procedures:

- At room temperature
- Constant flow rate during the test, liquid speed > 1 m/s
- Pressure: > 30 Kpa
- Flow condition: observed inlet and outlet conditions
- Zero point stability: $\pm 0.005\%$
- Default configuration if ordered together with sensor Type S051, S054, S055, S056. Detailed information can be found in chapter [“3.2. Default configuration” on page 14.](#)

Measurement deviation	$\leq \pm 0.8\%$ of the measured value (optional: $\pm 0.4\%$ of the measured value) for flow velocity > 0.5 m/s Detailed information can be found in chapter “3.1. Measurement deviation diagram” on page 13.
-----------------------	---

Repeatability	$\leq \pm 0.4\%$ of the measured value (optional: $\pm 0.2\%$ of the measured value) for flow velocity > 0.5 m/s
---------------	--

Response time	Minimum time <ul style="list-style-type: none"> • for analogue output (AO), when damping setting is deactivated and according to sensor size: <ul style="list-style-type: none"> – DN 03...DN 250: 20 ms – DN 300...DN 400: 100 ms • for digital output: <ul style="list-style-type: none"> – 100 ms (if used with the sensor Type S054 or Type S055) – 20 ms (if used with the sensor Type S051 or Type S056)
---------------	--

Electrical data

Operating voltage	<ul style="list-style-type: none"> • 100...240 V AC, 44 Hz...66 Hz • 12...48 V DC • Others on request
Power consumption	Max. 20 VA with 100...240 V AC operating voltage
Input	1 digital, function use is configurable (e.g. Totalizer reset)
Output	<ul style="list-style-type: none"> • Transistor: 2 digital outputs (DO), both with open collector configurable as <ul style="list-style-type: none"> – pulse/frequency (1250 Hz, max. 100 mA, 30 V DC) or – alarm • Current: <ul style="list-style-type: none"> – max. 2 analogue outputs (AO), 0/4...20/22 mA, RL = 1000 Ω – HART (optional) only over first analogue output • Serial interface (optional): RS-485 (available with Modbus protocol (option))
Galvanic isolation	All the input/outputs are galvanically isolated up to 250 V from operating voltage
Protection class	Class I
Connection cable	Between sensor and transmitter: <ul style="list-style-type: none"> • Cable C015/C016 for remote variant • 10 m (other lengths on request) Detailed information can be found in data sheets, see data sheet Type S051 ▶, data sheet Type S054 ▶, data sheet Type S055 ▶, data sheet Type S056 ▶.

Medium data

Velocity range	0.4...10 m/s
Minimum conductivity	5 $\mu\text{S}/\text{cm}$

Connections & communication

Electrical connection	<ul style="list-style-type: none"> • 5 cable glands PG11 for aluminium or nylon housing or • 6 cable glands PG11 for stainless steel housing
Plug for configuration connection	USB port for the connection to PC (USB cable with USB mini B and USB type A connectors is required for the programming)

Industrial communication	<ul style="list-style-type: none"> • RS-485 • Wi-Fi (as alternative for remote device configuration)
Protocol	<ul style="list-style-type: none"> • Modbus over RS-485 • HART (available on first analogue output)

Approvals and certificates

Directives

CE directive The applied standards, which verify conformity with the EU Directives, can be found on the EU Type Examination Certificate and/or the EU Declaration of conformity (if applicable).

Environment and installation

Ambient temperature	<p>Operation and storage</p> <ul style="list-style-type: none"> • Aluminium or stainless steel housing: -20...+60 °C (-4...+140 °F) • Reinforced nylon: -10...+50 °C (+14...+122 °F)
Relative air humidity	0...100 %, without condensation
Height above sea level	-200 up to +4000 m
Operating condition	Continuous
Equipment mobility	Fixed device
Application range	Indoor and outdoor (protect the device against electromagnetic interference, ultraviolet rays and against the effects of climatic conditions)
Degree of protection according to IEC/EN 60529	<ul style="list-style-type: none"> • Aluminium housing: IP65, IP67 (IP 68 optional) • Reinforced nylon housing: IP65, IP67 • Stainless steel housing: IP65
Installation category	Category II according to UL/EN 61010-1
Pollution degree	Degree 2 according to UL/EN 61010-1

1.) Empty pipe functionality is not available if sensors are selected in the range of DN 03 to DN 20.

1.4. SE58 S transmitter



Product properties

Material

Lid	PA
Cover	PA6
Housing	<ul style="list-style-type: none"> • Painted Aluminium die casting or • Stainless steel AISI 304 (1.4301) raw or polished
Seal	NBR
Circular plug-in connector	Nickel plated brass
Cable gland	PA
Display	LCD dimensions 60 x 40 mm, 2 lines + symbols, icons
Keypad	None
Compatibility	<p>Electromagnetic flow sensors Type S051, S054, S055, S056 in compact variant, up to DN 400.</p> <p>Detailed information can be found in data sheets, see data sheet Type S051 ▶, data sheet Type S054 ▶, data sheet Type S055 ▶, data sheet Type S056 ▶.</p>
Dimensions	Detailed information can be found in chapter " 2. Dimensions " on page 9.
Parametrisation	<p>Remote configuration by USB cable and PC tool MCP. However, any changes using MCP are not recommended, unless:</p> <ul style="list-style-type: none"> • after receiving corresponding training by Burkert, • done by professional, • agreed by the end user, and • done inline with the MCP manual <p>Detailed information can be found in chapters "4. Product operation" on page 15, "5. Product accessories" on page 16 and "7.5. Ordering chart accessories" on page 22.</p>
Data-logger	An EEPROM stores the measured values (in case of power failure)

Special function	Bidirectional measure
Performance data	
At reference conditions and according to internal test procedures:	
<ul style="list-style-type: none"> • At room temperature • Constant flow rate during the test, liquid speed > 1 m/s • Pressure: >30 Kpa • Flow condition: observed inlet and outlet conditions • Zero point stability: $\pm 0.005\%$ • Default configuration if ordered together with sensor Type S051, S054, S055, S056. Detailed information can be found in chapter "3.2. Default configuration" on page 14. 	
Measurement deviation	$\leq \pm 0.5\%$ of the measured value for flow velocity > 0.5 m/s Detailed information can be found in chapter "3.1. Measurement deviation diagram" on page 13.
Response time	Minimum time <ul style="list-style-type: none"> • for analogue output (AO), when damping setting is deactivated and according to sensor size: <ul style="list-style-type: none"> – DN 03...DN 250: 20 ms – DN 300...DN 400: 100 ms • for digital output: <ul style="list-style-type: none"> – 100 ms (if used with the sensor Type S054 or Type S055) – 20 ms (if used with the sensor Type S051 or Type S056)
Repeatability	$\leq \pm 0.25\%$ of the measured value for flow velocity > 0.5 m/s
Electrical data	
Operating voltage	<ul style="list-style-type: none"> • 12...30 V DC if not using mA output • 18...30 V DC if using mA output
Power consumption	Max. 1 W
Input	None
Output	<ul style="list-style-type: none"> • Digital output (DO): 2 outputs for pulses according to a flow rate or for alarms • Analogue output (AO): current output, 0/4...20 mA, RL = 500 Ω (18...30 V DC)
Protection class	Class I
Medium data	
Velocity range	0.4...10 m/s
Minimum conductivity	20 $\mu\text{S}/\text{cm}$
Connections & communication	
Electrical connection	<ul style="list-style-type: none"> • 1 x 5 pin M12 female connector (included in the delivery) or • Cable gland with 2 meter cable already connected
Plug for configuration connection	USB port for the connection to PC (USB cable with USB mini B and USB type A connectors is required for the programming)
Approvals and certificates	
Directives	
CE directive	The applied standards, which verify conformity with the EU Directives, can be found on the EU Type Examination Certificate and/or the EU Declaration of conformity (if applicable).
Environment and installation	
Ambient temperature	Operation and storage: <ul style="list-style-type: none"> • if analog output used: -20...+60 °C (-4...+140 °F) • if no analog output used: -10...+60 °C (14...+140 °F)
Relative air humidity	0...100 %, without condensation
Height above sea level	-200 up to +2000 m
Operating condition	Continuous
Equipment mobility	Fixed device
Application range	Indoor and outdoor (protect the device against electromagnetic interference, ultraviolet rays and against the effects of climatic conditions)
Degree of protection according to IEC/EN 60529	IP65, IP67 (IP68 optional)
Installation category	Category II according to UL/EN 61010-1
Pollution degree	Degree 2 according to UL/EN 61010-1

2. Dimensions

2.1. SE58 L and SE58 M transmitter

Compact variant with housing in aluminium or reinforced nylon

Note:

Dimensions in mm, unless otherwise stated

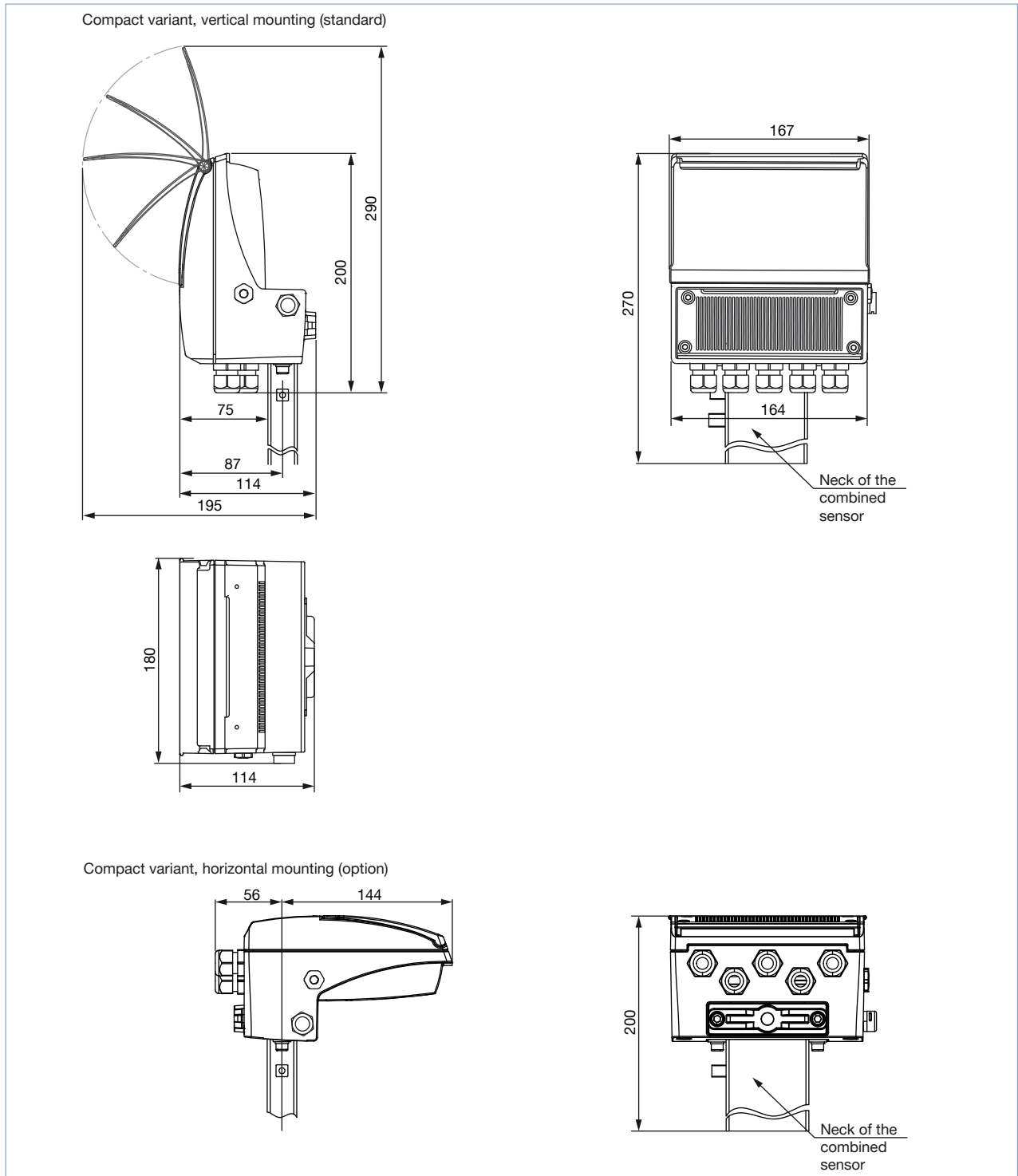

Remote variant with housing in aluminium or reinforced nylon

Note:

Dimensions in mm, unless otherwise stated

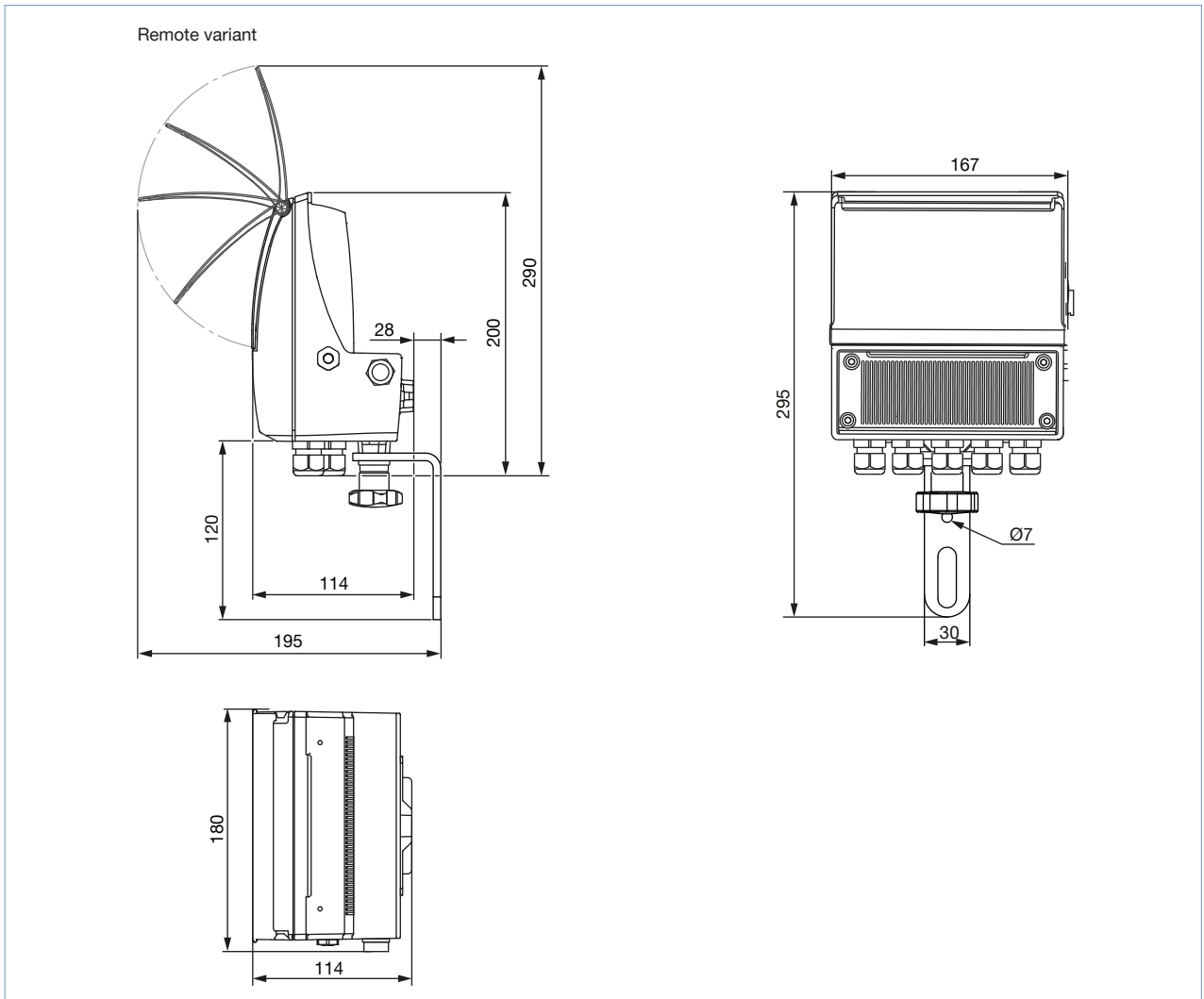

Compact and remote variants with housing in stainless steel

Note:

Dimensions in mm, unless otherwise stated

Compact variant

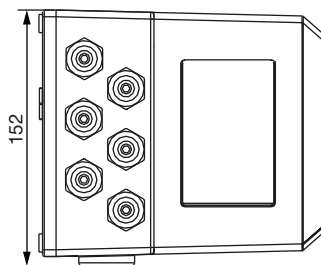
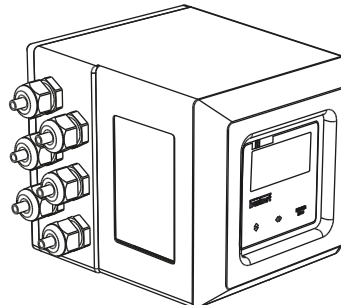
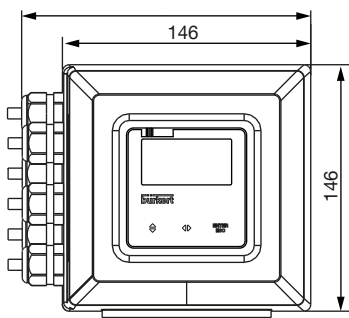
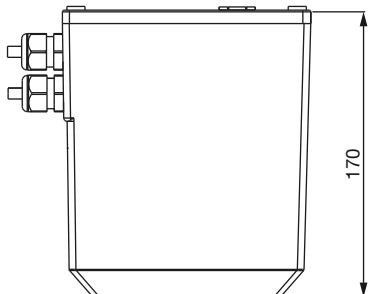

Remote variant

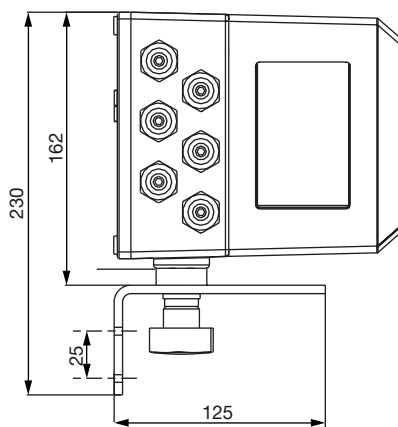
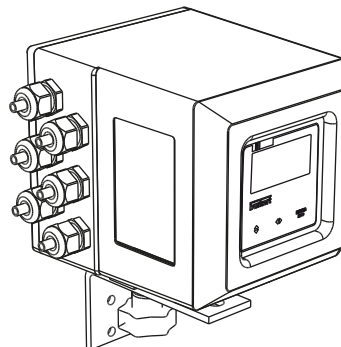
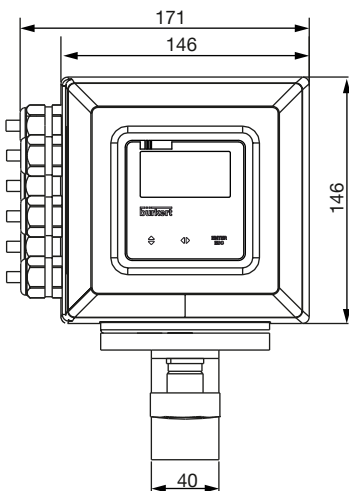
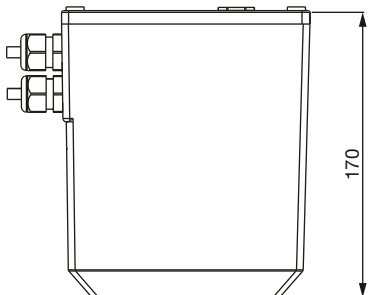

DTS 1000463561 EN Version: D Status: RL (released | freigegeben | validé) printed: 11.08.2023

2.2. SE58 S transmitter

Note:

Dimensions in mm, unless otherwise stated

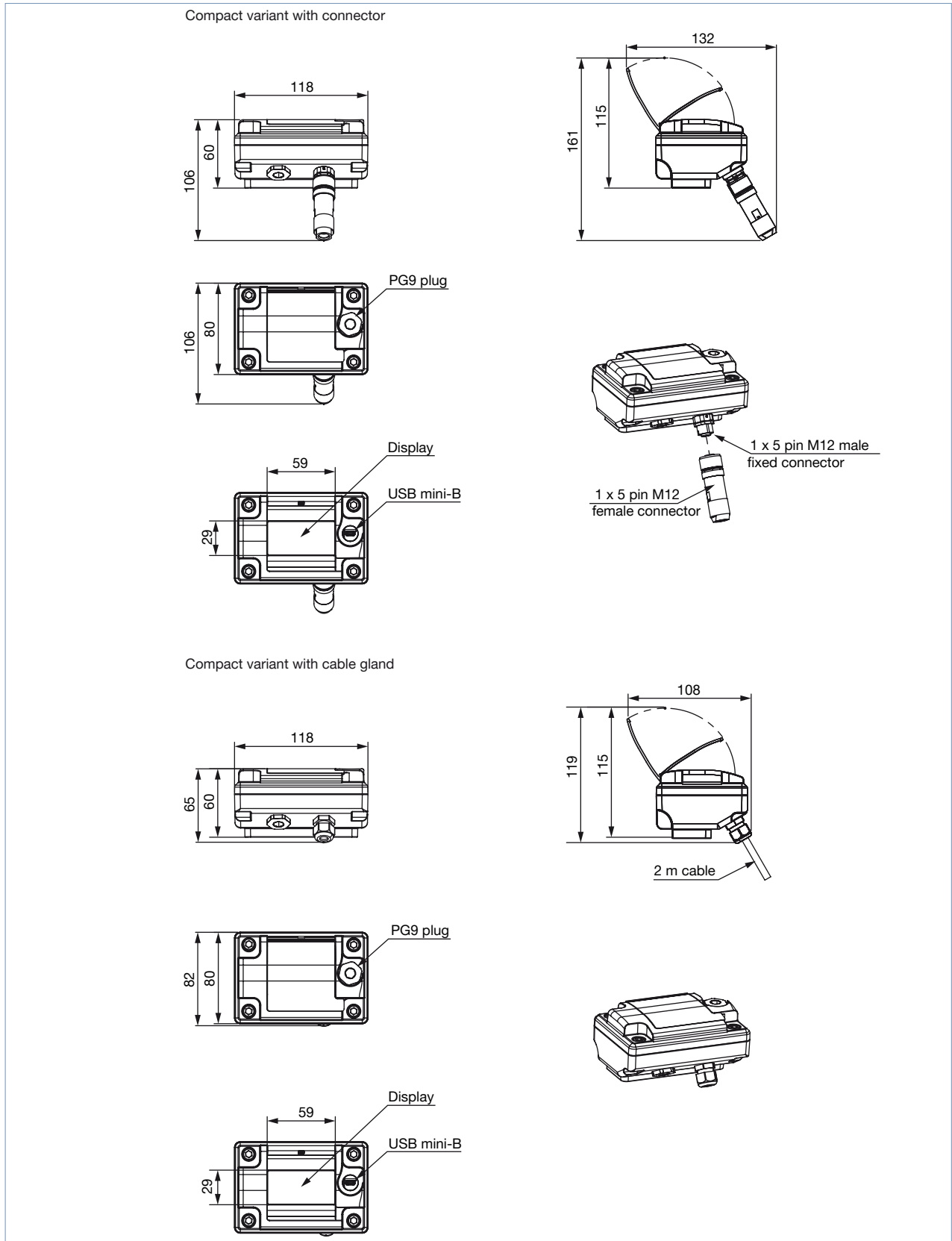

DTS 1000463561 EN Version: D Status: RL (released | freigegeben | valide) printed: 11.08.2023

3. Performance specifications

3.1. Measurement deviation diagram

SE58 L transmitter

Note:

This following diagram is valid for the complete device (Transmitter Type SE58 L combined with a flow sensor Type S051, S054, S055 or S056).

See [data sheet Type S051](#) ▶, [data sheet Type S054](#) ▶, [data sheet Type S055](#) ▶, [data sheet Type S056](#) ▶

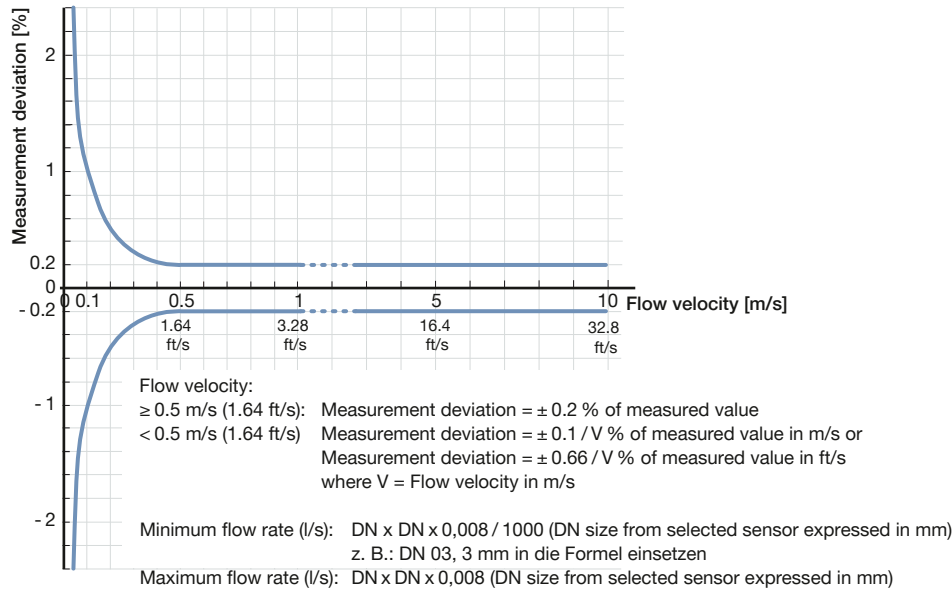

SE58 M transmitter

Note:

This following diagram is valid for the complete device (Transmitter Type SE58 M combined with a flow sensor Type S051, S054, S055 or S056).

See [data sheet Type S051](#) ▶, [data sheet Type S054](#) ▶, [data sheet Type S055](#) ▶, [data sheet Type S056](#) ▶

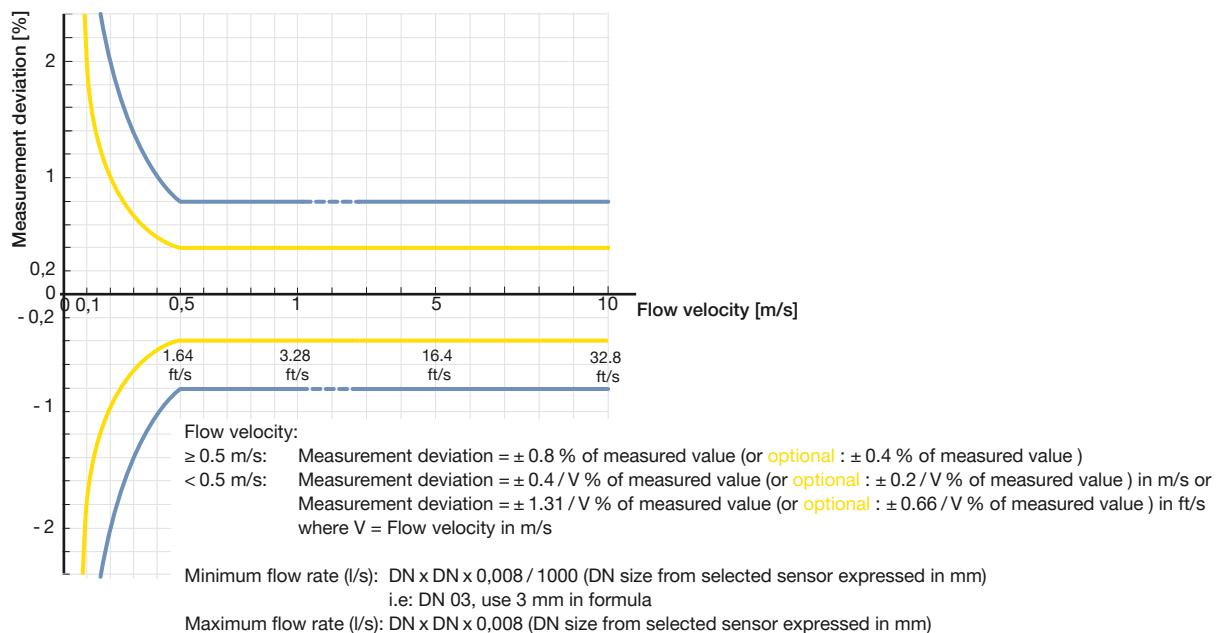

DTS 1000463561 EN Version: D Status: RL (released | freigegeben | valide) printed: 11.08.2023

SE58 S transmitter

Note:

This following diagram is valid for the complete device (Transmitter Type SE58 L and flow sensor Type S051, S054, S055 or S056).

See [data sheet Type S051](#) ▶, [data sheet Type S054](#) ▶, [data sheet Type S055](#) ▶, [data sheet Type S056](#) ▶

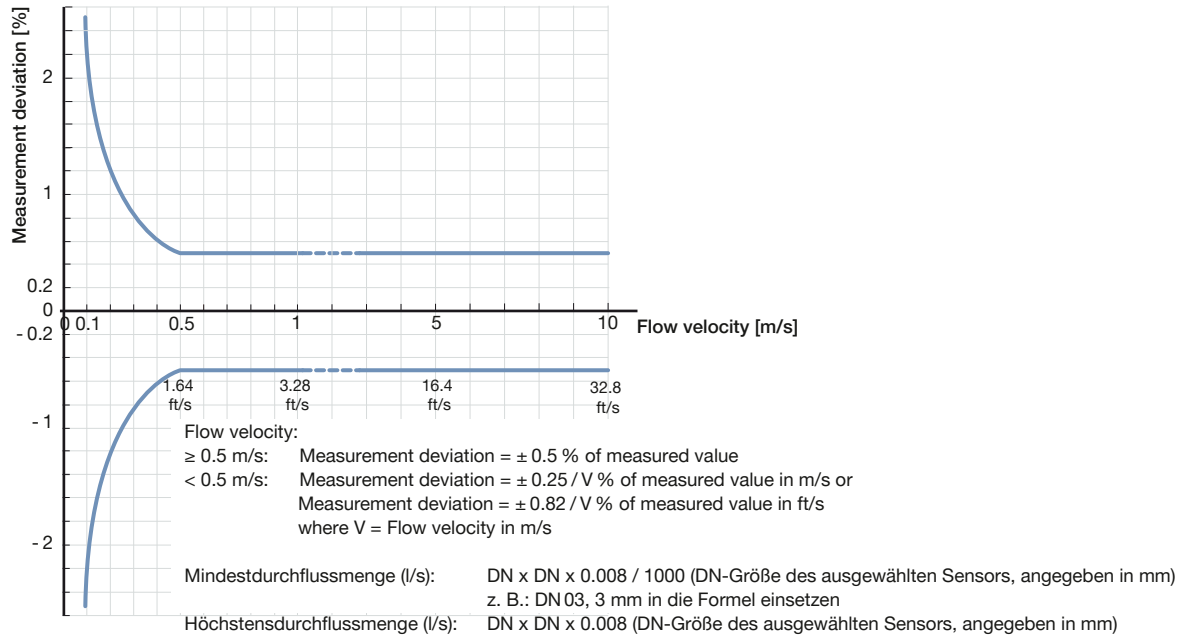

3.2. Default configuration

Note:

This following diagram is valid for the complete device (Transmitter Type SE58 L, SE58 M or SE58 S combined with a flow sensor Type S051, S054, S055 or S056).

See [data sheet Type S051](#) ▶, [data sheet Type S054](#) ▶, [data sheet Type S055](#) ▶, [data sheet Type S056](#) ▶

DN	3	6	10	15	20	25	32	40	50	65	80	100	125	150	200	250	300	350	400	450	500
At 4 mA in m³/h	0	0	0	0	0	0	0	0	0	0	0	0	0	0	0	0	0	0	0	0	0
At 20 mA in m³/h	0.1	0.6	2	4	8	16	25	40	63	120	160	250	400	630	1000	1600	2500	2500	4000	4000	6300
Liter per pulse	0.1	0.1	0.1	0.1	0.1	0.1	0.1	0.1	0.5	0.5	1	2	10	10	10	10	10	10	10	100	100

DTS 1000463561 EN Version: D Status: RL (released | freigegeben | valide) printed: 11.08.2023

4. Product operation

The configuration can be done in two different ways:

- By keypad of transmitter if equipped with display (except for transmitter SE58 S)
- By USB cable and PC tool MCP (virtual display of instrument) for transmitter with or without display.

This MCP software runs under MS-Windows and it is available for download on Bürkert's website for free. However any changes using MCP are not recommended, unless:

- after receiving corresponding training by Bürkert,
- done by professional,
- agreed by the end user, and
- done inline with the MCP manual which can be found under **Type SE58** ▶ on Bürkert's website.

With using this MCP software you agree to the following Software Tools End User License Agreement "MCP" (STEULA):

Permission is hereby granted, free of charge, to any person obtaining a copy of this software and associated documentation files (the "Software") to use the Software, and to permit persons to whom the Software is furnished to do so, subject to the conditions of this STEULA.

In a nutshell:

- The Software is intended for use by professionals and professionally, and in connection with our products only;
- While we took care to provide access to a convenient tool, it is not required for the use of our products; we cannot be liable for any consequence in using this Software;
- We will update the Software from time to time based but not regularly and may at any point in time discontinue to offer the Software or its updates for download.
- The Software could include technical or other mistakes, inaccuracies or typographical errors.
- At any time without prior notice, we may make changes to the software pointing to third-party websites or shops or documentation made available on the third-party's website.
- The software may be out of date, and we make no commitment to update such materials.

Legal advise:

1. One registered copy of supplied software may either be used by a single person who uses the software personally on one or more computers, or installed on a single computer used non-simultaneously by multiple people, but not both.
2. You may access to software through a network, provided that you have obtained and agreed to individual licenses for the software covering all computers that will access the software through the network regardless if they access the software program concurrently or at different times.
3. You are not allowed to modify its content, decompose, decompile its components, redistribute, offer or sell the Software.
4. You are solely responsible for determining the appropriateness of using the software and assume any risks associated with your exercise of permissions under this license.
5. **This software and any accompanying files are given free of charge "as is" and without warranties, express or implied, as to performance or merchantability or non-infringement of third party rights.**
6. No advice or information, whether oral or written, obtained by you from us shall create any warranty for the software.
7. Good data processing procedure dictates that any program shall be thoroughly tested in a non-critical environment before using the Software. You must assume the entire risk of using the program. **Note that using the software impacts the operability / functionality of the hardware and may have severe consequences for the production of the facility the hardware is installed in.**
8. **The software is in particular not designed, intended, licensed, or authorized for use in any type of system or application in which the failure of the system or application could create a situation where personal injury or death may occur (e.g., medical systems, life support, life-sustaining systems, life-saving systems, or security systems) or in hazardous environments requiring fail-safe controls, including without limitation, the design, construction, maintenance or operation of nuclear facilities, aircraft navigation or communication systems, air traffic control, or weapons systems. Licensor specifically disclaims any express or implied warranty of fitness for such purposes.**
9. **In no event shall we be liable for any direct, indirect, incidental, special, exemplary, or consequential damages (including, but not limited to, procurement of substitute goods or services; loss of use, data, or profits; or business interruption) however caused and on any theory of liability, whether in contract, strict liability, or tort (including negligence or otherwise) arising in any way out of the use of this software, even if advised of the possibility of such damage**

To download the MCP software, see **Type SE58** ▶ on Bürkert's website.

5. Product accessories

An USB cable with USB mini B and USB type A connectors serves as the interface between computer and transmitter (see “7.5. Ordering chart accessories” on page 22 and “4. Product operation” on page 15).

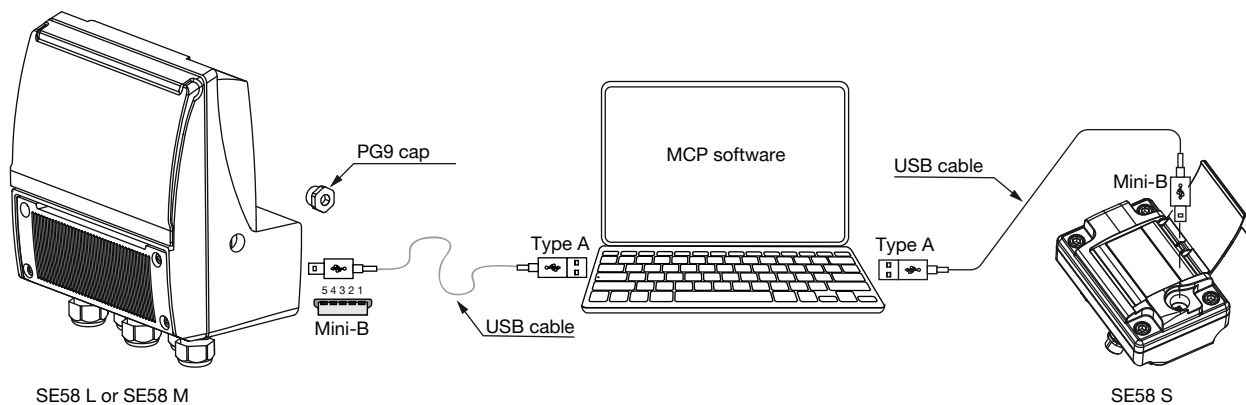

DTS 1000463561 EN Version: D Status: RL (released | freigegeben | valide) printed: 11.08.2023

6. Networking and combination with other Bürkert products

6.1. Compact variant

Note:

The compact Type SE58 transmitter is intended for use with Type S051, S045, S055 or S056 compact flow sensors.

Example:



DTS 1000463561 EN Version: D Status: RL (released | freigegeben | valide) printed: 11.08.2023

6.2. Remote variant

Note:

The Type SE58 transmitter is intended for use with Type S051, S045, S055 or S056 flow sensors, each in design for the remote variant.

Example:

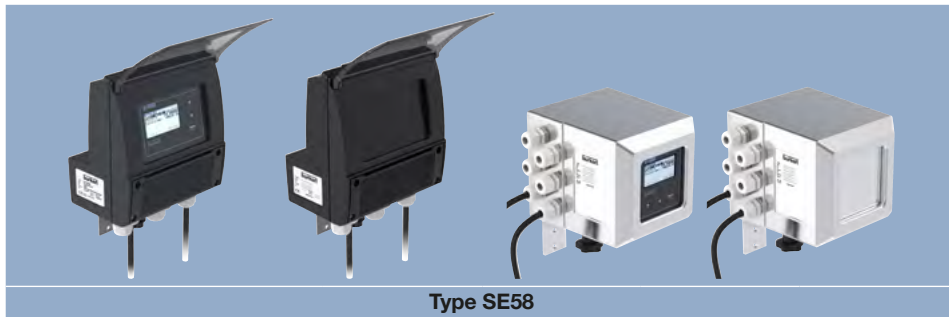

DTS 1000463561 EN Version: D Status: RL (released | freigegeben | valide) printed: 11.08.2023

7. Ordering information

7.1. Bürkert eShop



Bürkert eShop – Easy ordering and quick delivery

You want to find your desired Bürkert product or spare part quickly and order directly? Our online shop is available for you 24/7. Sign up and enjoy all the benefits.

[Order online now](#)

7.2. Recommendation regarding product selection

A complete full bore flowmeter consists of a flow sensor (compact or remote variant) Type S051, S054, S055 or S056 and a flow transmitter (compact or remote variant) Type SE58.

See [Data sheet Type S051](#) ▶, [Data sheet Type S054](#) ▶, [Data sheet Type S055](#) ▶, [Data sheet Type S056](#) ▶ for more information.

Two different components must be ordered in order to select a complete device. The following information is required:

- **Article no.** of the sensor **Type S051, S054, S055** or **S056** (see [Data sheet Type S051](#) ▶, [Data sheet Type S054](#) ▶, [Data sheet Type S055](#) ▶, [Data sheet Type S056](#) ▶ for more information.)
- **Article no.** of the transmitter **Type SE58** (see chapter [“7.4. Ordering chart”](#) on page 20, [“SE58 M transmitter”](#) on page 21 or [“SE58 S transmitter”](#) on page 22.)

7.3. Bürkert product filter



Bürkert product filter – Get quickly to the right product

You want to select products comfortably based on your technical requirements? Use the Bürkert product filter and find suitable articles for your application quickly and easily.













[Try out our product filter](#)

7.4. Ordering chart



SE58 L transmitter

Note:

- Not all SE58 L transmitter variants are listed in the following table; if the desired variant is not mentioned, please contact your Bürkert representative.
- The following variants are vertically mounted versions.

Operating voltage	Outputs	Industrial communication	Housing material	Electrical connection	Article no.
Compact variant with display					
100...240 V AC	2 digital outputs (transistors)	Without	Aluminium	5 cable glands	571500 
	2 digital outputs (transistors) + analogue output (4...20 mA)		Stainless steel	6 cable glands	571507 
12...48 V DC			Aluminium	5 cable glands	571501 
	2 digital outputs (transistors) + analogue output (4...20 mA)		Stainless steel	6 cable glands	571508 
12...48 V DC	2 digital outputs (transistors) + analogue output (4...20 mA)		Aluminium	5 cable glands	571502 
			Stainless steel	6 cable glands	571509 
Remote variant^{1.)} (wall-mounting) with display					
100...240 V AC	2 digital outputs (transistors)	Without	Aluminium	5 cable glands	571505 
	2 digital outputs (transistors) + analogue output (4...20 mA)		Stainless steel	6 cable glands	571510 
12...48 V DC			Aluminium	5 cable glands	571506 
	2 digital outputs (transistors) + analogue output (4...20 mA)		Stainless steel	6 cable glands	571511 
12...48 V DC	2 digital outputs (transistors) + analogue output (4...20 mA)		Aluminium	5 cable glands	571503 
			Stainless steel	6 cable glands	571513 

















1.) Remote variants include two 10 m signal cable. If a longer cable is needed please consider that for ordering.

Further versions on request	
	Material Nylon reinforced
	Approval IP68
	Additional <ul style="list-style-type: none"> • Compact variant for horizontal mounting or remote version • Variant with display (visible from the top or from the front) or without display • Outputs: <ul style="list-style-type: none"> – 4...20 mA (one or two) – RS 485 (with protocol Modbus) – 2 transistors • Industrial communication: <ul style="list-style-type: none"> – RS 485 (with protocol Modbus) – HART – Wi-Fi (for parameter settings) • Data logger with Micro-SD memory 4GB

SE58 M transmitter

Note:

- Not all SE58 M transmitter variants are listed in the following table; if the desired variant is not mentioned, please contact your Bürkert representative.
- The following variants are vertically mounted versions and delivered with a measurement deviation of 0.8 % from the measured value.

Operating voltage	Outputs	Industrial communication	Housing material	Electrical connection	Article no.
Compact variant with display					
100...240 V AC	2 digital outputs (transistors)	Without	Nylon reinforced	5 cable glands	571540 
			Stainless steel	6 cable glands	571548 
	2 digital outputs (transistors) + analogue output (4...20 mA)		Nylon reinforced	5 cable glands	571541 
			Stainless steel	6 cable glands	571549 
12...48 V DC	2 digital outputs (transistors)	Without	Nylon reinforced	5 cable glands	571542 
			Stainless steel	6 cable glands	571550 
	2 digital outputs (transistors) + analogue output (4...20 mA)		Nylon reinforced	5 cable glands	571543 
			Stainless steel	6 cable glands	571551 
Compact variant without display					
100...240 V AC	2 digital outputs (transistors)	Without	Nylon reinforced	5 cable glands	571544 
			Stainless steel	6 cable glands	571552 
	2 digital outputs (transistors) + analogue output (4...20 mA)		Nylon reinforced	5 cable glands	571545 
			Stainless steel	6 cable glands	571553 
12...48 V DC	2 digital outputs (transistors)	Without	Nylon reinforced	5 cable glands	571546 
			Stainless steel	6 cable glands	571554 
	2 digital outputs (transistors) + analogue output (4...20 mA)		Nylon reinforced	5 cable glands	571547 
			Stainless steel	6 cable glands	571555 

Further versions on request



Material
Aluminium



Approval
IP68

**Additional**

- Compact variant for horizontal mounting or remote version
- Variant with display (visible from the top or from the front) or without display
- Outputs :
 - 4...20 mA (one or two)
 - RS 485 (with protocol Modbus)
 - 2 transistors
- Measurement deviation of 0.4 % of the measured value
- Industrial communication:
 - RS 485 (with protocol Modbus)
 - HART
 - Wi-Fi (for parameter settings)
- Data logger with Micro-SD memory 4GB

SE58 S transmitter

Note:

- Not all SE58 S transmitter variants are listed in the following table; if the desired variant is not mentioned, please contact your Bürkert representative.

Operating voltage	Outputs	Industrial communication	Housing material	Electrical connection	Article no.
Compact variant with display					
12...30 V DC ^{1.)}	2 digital outputs (transistors)	Without	Stainless steel polished	Cable gland with 2 m cable already connected	571582
	2 digital outputs (transistors) + analogue output (4...20 mA)				571583
Compact variant without display					
12...30 V DC ^{1.)}	2 digital outputs (transistors)	Without	Stainless steel polished	Cable gland with 2 m cable already connected	571580
	2 digital outputs (transistors) + analogue output (4...20 mA)				571581

1.) 12...30 V DC if not using mA output or 18...30 V DC if using mA output

Further versions on request	
Electrical connection 1 x 5 pin M12 female connector	Additional Variant with display
Material Aluminium, stainless steel raw, stainless steel polished	Approval IP68

7.5. Ordering chart accessories

Description	Article no.
USB cable with connector mini B and A, length 1.8 m	919499

Bürkert – Close to You

For up-to-date addresses
please visit us at
www.burkert.com

DTS 1000463561 EN Version: D Status: RL (released | freigegeben | validé) printed: 11.08.2023

Austria
Belgium
Czech Republic
Denmark
Finland
France
Germany
Italy
Netherlands

Norway
Poland
Spain
Sweden
Switzerland
Turkey
United Kingdom

